

MAGNUSON GROUP

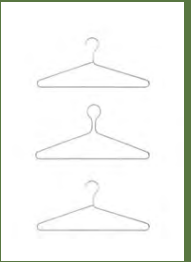

ARCHITECTURAL DIVISION 10
PRICE LIST AND SPECIFICATIONS
EFFECTIVE APRIL 1, 2024



TERMS AND CONDITIONS • APRIL 1, 2023 SPECIFICATIONS AND PRICE LIST

Cash Terms: Net 30 days. A service charge of 1% per month will be assessed on all past due accounts. Custom orders will require a deposit in advance. First orders by new accounts will be on VISA, Master Card, Discover, American Express or check in advance. Open accounts may be established upon submission and approval of three trade references and bank information.

Non-Stock Orders: All orders for items that are not in stock may require a 50% non-refundable deposit at time of order placement. The order will not be processed until the deposit is received.

Large Orders: Orders over \$10,000 net may require a 25% deposit at time of order placement.

Mail, E-Mail and Fax Orders: Mail, E-mail, and fax are the only acceptable methods of placing orders. If a confirming order is sent, it must be marked "CONFIRMING ORDER". Duplicate orders not marked "CONFIRMING ORDER" are the responsibility of the buyer.

Order Acknowledgement: Magnuson Group will confirm the buyers purchase order.

Delays in Delivery: Magnuson Group will not be held liable for failure to ship or deliver on or by any particular date.

Freight Classification: Classification can vary greatly based upon what and how much is ordered.

Freight Terms: F.O.B. Woodridge, Illinois. Freight charges are prepaid and added to invoice at time of shipment unless 3rd party billing is specified on the order.

Title to Merchandise: Once Magnuson Group delivers the product to the carrier, title to the merchandise and risk of loss passes to the buyer. We are not responsible for loss or damage during transit. All freight claims are the responsibility of the purchaser or consignee.

Shipping Damage/Shortage Claims: All shipments should be inspected carefully on delivery, and any apparent damage or shortages noted as exceptions on all copies of the delivery receipt. Notification of shortages or concealed damage must be made to the delivering carrier within 3 days of receipt.

Claims of either visible or concealed damage should be presented without delay to the carrier by the consignee.

Shortage Claims: Shortage claims reported 30 days beyond shipment date will not be honored.

Routing: UPS or Federal Express Ground will be used where size and weight restrictions allow. On larger shipments common carrier will be used.

Order Changes: Changes to orders in process are subject to approval and to the same conditions as cancellations.

Cancellations and Returns: Orders in any stage of processing and production may not be cancelled without authorization in writing from Magnuson Group and may be subject to a 50% cancellation fee. If a return is authorized, a minimum restocking charge of 30% will be incurred, return freight pre-paid. Returned goods must be unused and packaged in original cartons within 90 days of original shipping date. Custom orders cannot be returned. Credit will be issued subject to inspection by our receiving department.

Price and Design Changes: All prices are subject to change without notice and prices in effect at time of shipment will prevail. Magnuson Group reserves the right to improve product design, construction and quality without notice.

Warranty: All products and parts are warranted against defects in material and workmanship for the period of (2) years after shipment. Warranty is void if product is damaged through accident, improper use, abuse, or alteration.

Limitation of Liability: Magnuson Group's liability for any and all losses and damages to buyer resulting from any cause shall be limited only to the replacement or the repair of the product.

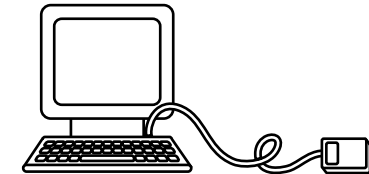

For Your Convenience: As an alternative to cash terms, we accept Visa, MasterCard, Discover and American Express.

Save on Shipping Costs: Many items in this line qualify for United Parcel Service routing.

Visit us at our Web Site: www.magnusongroup.com

THE MAGNUSON GROUP ENVIRONMENTAL STATEMENT

MANUFACTURING PRACTICES

Manufacturing Process

The manufacturing process with Slope starts with partially recycled steel. The cold rolled carbon steel is formed and given a paint color with a low emitting powder coating.

All steel is sourced locally, within 95 miles of Magnuson Group's headquarters in Woodridge, IL, where final assembly occurs. Magnuson Group's vendors are carefully selected based on craftsmanship, location and environmental practices among other considerations

MAINTENANCE & USE & DISPOSAL

Cleaning

Slope can be cleaned using a damp cloth and mild non-abrasive cleaner.

Ergonomic

Product is designed for ergonomic use, which will continue to service life.

Recycling

At the end of its life cycle, Slope can be disassembled and recycled. The body is made primarily of steel, one of the most recycled materials on the planet, and the internal rigid liner is made of plastic, which is also easily recyclable. Receptacle is designed to maximize recycling rates through design, graphics, and signage placement.

MAGNUSON GROUP GENERAL SUSTAINABILITY PRACTICES

Magnuson Group recognizes the importance of being good stewards to the earth. We incorporate positive environmental processes into all facets of the company. Whether the process is administrative in nature, or is in manufacturing, Magnuson Group strives to ensure that environmental concerns are made a part of the system. Some specifics include:











	Type	Description
	Steel	All steel scrap is 100% recycled. Steel is manufactured with 30-40% post consumer material and is 100% recyclable.
	Wood	Magnuson Group strives to always source wood from F.S.C. sources.
	Plastics	Plastics are 100% recyclable.
	Fabrics	Fabrics are manufactured from 100% post consumer materials, and is fire rated to: ASTM E-84 Class 1 or A.
	Aluminum	All aluminum scrap is 100% recycled. Aluminum comes from 10-20% post consumer material and is 100% recyclable.
	Packaging	Packaging comes from a minimum of 35% post consumer material and is 100% recyclable.
	Paints	All paints used are certified to be of low VOC content < 50g per liter. They emit no hazardous air pollutants (HAP) or noxious fumes when exposed to fire NFPA 704 Health = 1, Fire = 1, Reactivity = 0.
	Import	We import products from various countries in Europe. Most but not all are certified ISO 9001-14001 Environmental Management Systems. Please contact us if you need further information.
	Paper	All paper and packaging waste is 100% recycled.
	Plating	Plating is kept to the absolute minimum. Our plater's meet or exceed all Illinois EPA, Federal EPA, and OSHA mandated standards; all plating is RoHS compliant. Our plating emits no hazardous air pollutants (HAP) or noxious fumes when exposed to fire. We certify that there is no asbestos in any of the products we manufacture or import for sale.

TABLE OF CONTENTS

🕒 PRODUCT PRICING 🌐 WEB PAGE 📄 PRODUCT SPEC PDF

COAT HANGERS

BASIC
FILO
GRIP
HANGER RECEPTACLES
MIRAC
MOLDED POLYSTYRENE HANGERS
STEEL HANGERS
TUBULUS
UNIVERSUM

COAT HOOK STRIPS

ALOES MEW
CLIMB
K SERIES HOOK PANELS
KOBE
KROK BOX
KROK HJH
MIRAC
NOMIS
ONA
SECOND TREE
SEI
SHERWOOD
SLIDE W

STAINLESS STEEL
STAL
STICKS HJH
TERTIO H
TERTIO HA
TERTIO HD
TERTIO HJH
YIN MYIW

COAT HOOKS

BAMBU
CANTHA
K SERIES HOOKS
KROK HJH-10
MIRAC
PC 550 SERIES
PC SERIES PANEL/DOOR
POINTO
S SERIES
S-SERIES ANTIMICROBIAL
SHERWOOD
STAL
TERTIO H-K
TREEHOOKED
TUBULUS H

COAT RACKS

FRAME
TERTIO
TERTIO W/K
TERTIO W2

CUSTOM LENGTH COAT RACKS

RIDGE HANGER FLOOR RACK (SHA)
RIDGE DOUBLE HANGER FLOOR RACK (DHA)
RIDGE HOOK FLOOR RACK (SKA)
RIDGE DOUBLE HOOK FLOOR RACK (DKA)
VILLA HANGER WALL RACK (WH01A)
VILLA DOUBLE HANGER WALL RACK (WH02A)
VILLA HOOK WALL RACK (WK01A)
VILLA DOUBLE HOOK WALL RACK (WK02A)
VILLA UTILITY/BOOT WALL RACK (WU01A)
VILLA HOOK STRIP (WEX)

HOSPITALITY RACKS

BURR UNDER SHELF RODS & BRACKETS (USR)

SANITIZATION & PPE STATIONS

HAANDER
ISBIT
SOLNA FREESTANDING
SOLNA WITH RECEPTACLE

SANITIZATION & PPE STATIONS

HOME → PRODUCTS → SANITIZATION & PPE STATIONS



HAANDER

FINISH COLORS



Lunar White



Anodized Silver



Textured Raven Black

ADDITIONAL NOTES

Ships via UPS

Magnuson Group does not sell hand sanitizer dispensers.

HAANDER's free standing and wall-mounted models are designed to work with a wide variety of 3rd party hand sanitizer dispenser units [both touch free and push style models]. Any dispenser that fits within 7 3/4" wide by 14" high is compatible and can be most easily mounted using double sided adhesive tape, which is often included with the dispenser.

HAANDER's mounting holes align with many PURELL® Push-Style Dispensers (NXT, ES4, FMX) and PURELL® Touch-Free Dispensers (TFX, LTX, ES6 & ES8), making installation easy. ©2015. GOJO Industries, Inc. All rights reserved.

HAANDER-W: Mounts to the wall with 4 screws. Dispensers are mounted to HAANDER-W using either double sided adhesive tape (often included with dispenser) or with hardware. If the dispenser is a compatible PURELL® product, mounting holes are aligned for easy installation with hardware.



HAANDER-F: Painted steel dispenser housing mounts to post with hardware provided. Dispensers are mounted to painted steel housing using either double sided adhesive tape (often included with dispenser) or with hardware if the dispenser is a compatible PURELL® product. Mounting the dispenser to the painted steel housing with hardware is not possible unless the dispenser is a compatible PURELL® product. The painted steel base is 1/4" high off the ground.

HAANDER-W includes 4 drywall screws and 4 wall anchors to mount HAANDER-W to drywall. For other applications, customer will need to supply their own hardware.

HAANDER-F includes all hardware to mount the dispenser housing to the freestanding post and base.

Sample chips available.



LINE ART	MODEL	H	W	D	WEIGHT	DESCRIPTION	COLOR/FINISH	LIST PRICE
	HAANDER-W	19"	8"	4"	5 lbs.	Wall mounted painted steel hand sanitizer dispenser station with silkscreened hand sanitizer graphic.	Lunar White, Anodized Silver or Textured Raven Black	240.00
	HAANDER-F	54 1/2"	15 1/2"	15 1/2"	43 lbs.	Freestanding painted steel hand sanitizer dispenser station with silkscreened hand sanitizer graphic.	Lunar White, Anodized Silver or Textured Raven Black	520.00

ISBIT

FINISH COLORS



Lunar White



Anodized Silver



Textured Raven Black

ADDITIONAL NOTES

Ships via UPS

Magnuson Group does not include hand sanitizer with ISBIT.

ISBIT is designed to be compatible with most 16.9oz (500ml) hand sanitizer pump bottles. The height of the body of the bottle (measured from bottom of the bottle to the bottom of the bottle neck) cannot exceed 6" in height in order to fit within the acrylic housing. The height of the bottle's pump at full compression must be above 6 1/2" in order to function within the acrylic housing.

ISBIT-W mounts to the wall with 4 screws. Hardware & wall anchors for drywall application are included with the product. For other applications, customer will need to supply their own hardware.

ISBIT-M mounts to any steel surface with two heavy duty magnets.

ISBIT-F painted steel frame and acrylic housing mounts to the post with hardware provided. The painted steel base is 1/4" high off the ground.

Sample chips available.



LINE ART	MODEL	H	W	D	WEIGHT	DESCRIPTION	COLOR/FINISH	LIST PRICE
	ISBIT-W	7 1/8"	5 1/8"	4"	2 lbs.	Wall mounted painted steel hand sanitizer station for pump bottle with removeable clear acrylic housing.	Lunar White, Anodized Silver or Textured Raven Black Frame with Clear Acrylic Housing.	240.00
	ISBIT-M	7 1/8"	5 1/8"	4"	2 lbs.	Magnetic painted steel hand sanitizer station for pump bottle with removeable clear acrylic housing.	Lunar White, Anodized Silver or Textured Raven Black Frame with Clear Acrylic Housing.	275.00
	ISBIT-F	40"	15 1/2"	15 1/2"	25 lbs.	Freestanding painted steel hand sanitizer station for pump bottle with removeable clear acrylic housing.	Lunar White, Anodized Silver or Textured Raven Black Frame, Post and Base with Clear Acrylic Housing.	500.00

SOLNA FREESTANDING

FINISH COLORS

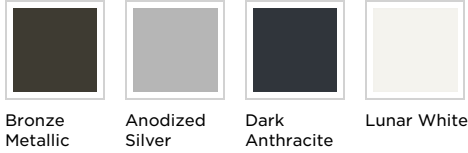

Bronze Metallic Anodized Silver Dark Anthracite Lunar White

GRAPHIC LABEL OPTIONS



Virus Prevention Disposable PPE Sanitizer Masks Wipes



Gloves Tissues Masks/Tissues Masks/Wipes Masks & Gloves

ADDITIONAL NOTES

Ships via common carrier.

Masks PPE cabinet is compatible with many standard disposable mask boxes. Designed for two mask boxes (stacked on top of one another) each measuring up to 7 ¾" high by 5" wide by 4 ¼" deep.

Gloves PPE cabinet is compatible with many standard disposable gloves and tissue boxes. Gloves PPE cabinet is designed for three gloves or tissues boxes up to 10" wide by 5" high by 4 ¼" deep.

SOLNA FREESTANDING PPE cabinets open from top to bottom and come with internal magnetic "L Bracket" that ensures secure fit for PPE. Masks PPE cabinet includes one magnetic "L Bracket". Masks & Gloves PPE cabinet includes two magnetic "L Brackets".

SOLNA is compatible with a wide variety of 3rd party hand sanitizer dispenser units [both touch free and push style models]. Any dispenser up to 10" wide by 12" high is compatible and can be most easily mounted using double sided adhesive tape, which is often included with the dispenser.

Magnuson Group does not sell hand sanitizer dispensers. SOLNA's mounting holes align with many PURELL® Push-Style Dispensers (NXT, ES4, FMX) and PURELL® Touch-Free Dispensers (TFX, LTX, ES6 & ES8), making installation easy. ©2015. GOJO Industries, Inc. All rights reserved.

Assembly required: Use hardware provided to attach the base to upright. Then, attach PPE cabinet or dispenser bracket to upright. SOLNA-FS-18-MD dispenser bracket and masks cabinet can be placed on either the left or right side (mounting holes are identical).

SOLNA meets or exceeds the minimum requirements per ANSI/BIFMA X5.6-2016 Panel Systems.

Sample chips available.

SANITIZATION & PPE OPTIONS







Dispenser Bracket Masks Masks & Gloves

GRAPHIC LABEL FINISH COLORS



White Vinyl Dark Grey Vinyl



LINE ART	MODEL	H	W	D	WEIGHT	DESCRIPTION	COLOR/FINISH	LIST PRICE
	SOLNA-FS-09-D	55 7/8"	11"	15"	38 lbs.	Freestanding sanitization station made of painted steel with drip tray for hand sanitizer dispenser, includes one label.	Dark Anthracite, Anodized Silver, Lunar White, Bronze Metallic	1,085.00
	SOLNA-FS-09-M	55 7/8"	11"	15"	40 lbs.	Freestanding PPE station made of painted steel with locking cabinet for masks, includes one label.	Dark Anthracite, Anodized Silver, Lunar White, Bronze Metallic	1,135.00
	SOLNA-FS-18-MD	55 7/8"	20"	15"	73 lbs.	Freestanding PPE & sanitization station made of painted steel with locking cabinet for masks & drip tray for hand sanitizer dispenser, includes one label.	Dark Anthracite, Anodized Silver, Lunar White, Bronze Metallic	1,695.00
	SOLNA-FS-18-MG	55 7/8"	20"	15"	77 lbs.	Freestanding PPE station made of painted steel with locking cabinet for masks & gloves, includes one label.	Dark Anthracite, Anodized Silver, Lunar White, Bronze Metallic	1,825.00

SOLNA WITH RECEPTACLE

FINISH COLORS



Bronze Metallic



Anodized Silver



Dark Anthracite



Lunar White

WASTE RECEPTACLE COMPATIBILITY



VALUTA
VA1814L



VALUTA
VA1818L



2x VALUTA
VA1809L



SOTARE
SO1818L



SOTARE
SO1818L-DBL

ADDITIONAL NOTES

Ships via common carrier.

Masks PPE cabinet is compatible with many standard disposable mask boxes. Designed for two mask boxes (stacked on top of one another) each measuring up to 7 ¼" high by 5" wide by 4 ¼" deep.

Gloves PPE cabinet is compatible with many standard disposable gloves and tissue boxes. Gloves PPE cabinet is designed for three gloves or tissues boxes up to 10" wide by 5" high by 4 ¼" deep.

SOLNA panel above receptacle opens from right to left to allow full range of motion for VALUTA or SOTARE lid. PPE cabinets open from top to bottom and comes with internal magnetic "L Bracket" that ensures secure fit for PPE. Masks PPE cabinet includes one magnetic "L Bracket". Masks & Gloves PPE cabinet includes two magnetic "L Brackets".

SOLNA with Receptacle cannot be positioned directly next to another SOLNA with Receptacle unit and must have a 9" gap or greater between adjacent units due to the hinged panel that opens from right to left. SOLNA with Receptacle can be positioned directly next to a VALUTA or SOTARE Waste Receptacle only.

SOLNA is compatible with a wide variety of 3rd party hand sanitizer dispenser units [both touch free and push style models]. Any dispenser up to 10" wide by 12" high is compatible and can be most easily mounted using double sided adhesive tape, which is often included with the dispenser.

Magnuson Group does not sell hand sanitizer dispensers. SOLNA's mounting holes align with many PURELL® Push-Style Dispensers (NXT, ES4, FMX) and PURELL® Touch-Free Dispensers (TFX, LTX, ES6 & ES8), making installation easy. ©2015. GOJO Industries, Inc. All rights reserved.

Assembly required: Use hardware provided to attach the panel to the VALUTA or SOTARE waste receptacle. Then, attach PPE cabinet or dispenser bracket to upright. On SOLNA-MD models, the dispenser bracket and masks cabinet can be placed on either the left or right side (mounting holes are identical).

Sample chips available.

SANITIZATION & PPE OPTIONS

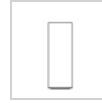

Dispenser
Bracket



Masks



Masks &
Gloves

HOW TO ORDER



Select
SOLNA
Model



Select Color



Select
VALUTA or
SOTARE
Unit(s)



Select Body
Color



Select Top
Color















Select Top
Opening



Select Label
& Color



LINE ART	MODEL	H	W	D	WEIGHT	DESCRIPTION	COLOR/FINISH	LIST PRICE
	SOLNA-ADD-18-MD	55 7/8"	18"	5 3/4"	26 lbs.	Add on SOLNA panel to retrofit existing VALUTA or SOTARE Waste Receptacles for PPE & sanitization. Made of painted steel with locking cabinet for masks & driptray for hand sanitizer dispenser.	Dark Anthracite, Anodized Silver, Lunar White, Bronze Metallic	1,195.00
	SOLNA-ADD-18-MG	55 7/8"	18"	5 3/4"	30 lbs.	Add on SOLNA panel to retrofit existing VALUTA or SOTARE Waste Receptacles for PPE. Made of painted steel with locking cabinet for masks & gloves.	Dark Anthracite, Anodized Silver, Lunar White, Bronze Metallic	1,195.00
	SOLNA-PLUS-18-MD-VA1814L	55 7/8"	18"	15 1/2"	73 lbs.	VALUTA VA1814L receptacle with SOLNA PPE & sanitization station made of painted steel with locking cabinet for masks & driptray for hand sanitizer dispenser.	Dark Anthracite, Anodized Silver, Lunar White, Bronze Metallic	2,290.00
	SOLNA-PLUS-18-MG-VA1814L	55 7/8"	18"	15 1/2"	77 lbs.	VALUTA VA1814L receptacle with SOLNA PPE station made of painted steel with locking cabinet for masks & gloves.	Dark Anthracite, Anodized Silver, Lunar White, Bronze Metallic	2,290.00
	SOLNA-PLUS-18-MD-VA1818L	55 7/8"	18"	19 1/2"	80 lbs.	VALUTA VA1818L receptacle with SOLNA PPE & sanitization station made of painted steel with locking cabinet for masks & driptray for hand sanitizer dispenser.	Dark Anthracite, Anodized Silver, Lunar White, Bronze Metallic	2,390.00
	SOLNA-PLUS-18-MG-VA1818L	55 7/8"	18"	19 1/2"	84 lbs.	VALUTA VA1818L receptacle with SOLNA PPE station made of painted steel with locking cabinet for masks & gloves.	Dark Anthracite, Anodized Silver, Lunar White, Bronze Metallic	2,390.00
	SOLNA-PLUS-18-MD-2xVA1809L	55 7/8"	18"	19 1/2"	86 lbs.	VALUTA VA1809L receptacles with SOLNA PPE & sanitization station made of painted steel with locking cabinet for masks & driptray for hand sanitizer dispenser.	Dark Anthracite, Anodized Silver, Lunar White, Bronze Metallic	3,185.00
	SOLNA-PLUS-18-MG-2xVA1809L	55 7/8"	18"	19 1/2"	90 lbs.	VALUTA VA1809L receptacles with SOLNA PPE station made of painted steel with locking cabinet for masks & gloves.	Dark Anthracite, Anodized Silver, Lunar White, Bronze Metallic	3,185.00
	SOLNA-PLUS-18-MD-SO1818L	55 7/8"	18"	19 1/2"	75 lbs.	SOTARE SO1818L receptacle with SOLNA PPE & sanitization station made of painted steel with locking cabinet for masks & driptray for hand sanitizer dispenser.	Dark Anthracite, Anodized Silver, Lunar White, Bronze Metallic	3,190.00
	SOLNA-PLUS-18-MG-SO1818L	55 7/8"	18"	19 1/2"	79 lbs.	SOTARE SO1818L receptacle with SOLNA PPE station made of painted steel with locking cabinet for masks & gloves.	Dark Anthracite, Anodized Silver, Lunar White, Bronze Metallic	3,190.00
	SOLNA-PLUS-18-MD-SO1818L-DBL	55 7/8"	18"	19 1/2"	75 lbs.	SOTARE SO1818L-DBL double top opening receptacle with SOLNA PPE & sanitization station made of painted steel with locking cabinet for masks & driptray for hand sanitizer dispenser.	Dark Anthracite, Anodized Silver, Lunar White, Bronze Metallic	3,390.00
	SOLNA-PLUS-18-MG-SO1818L-DBL	55 7/8"	18"	19 1/2"	79 lbs.	SOTARE SO1818L-DBL double top opening receptacle with SOLNA PPE station made of painted steel with locking cabinet for masks & gloves.	Dark Anthracite, Anodized Silver, Lunar White, Bronze Metallic	3,390.00

COAT HOOKS

HOME → PRODUCTS → COAT HOOKS

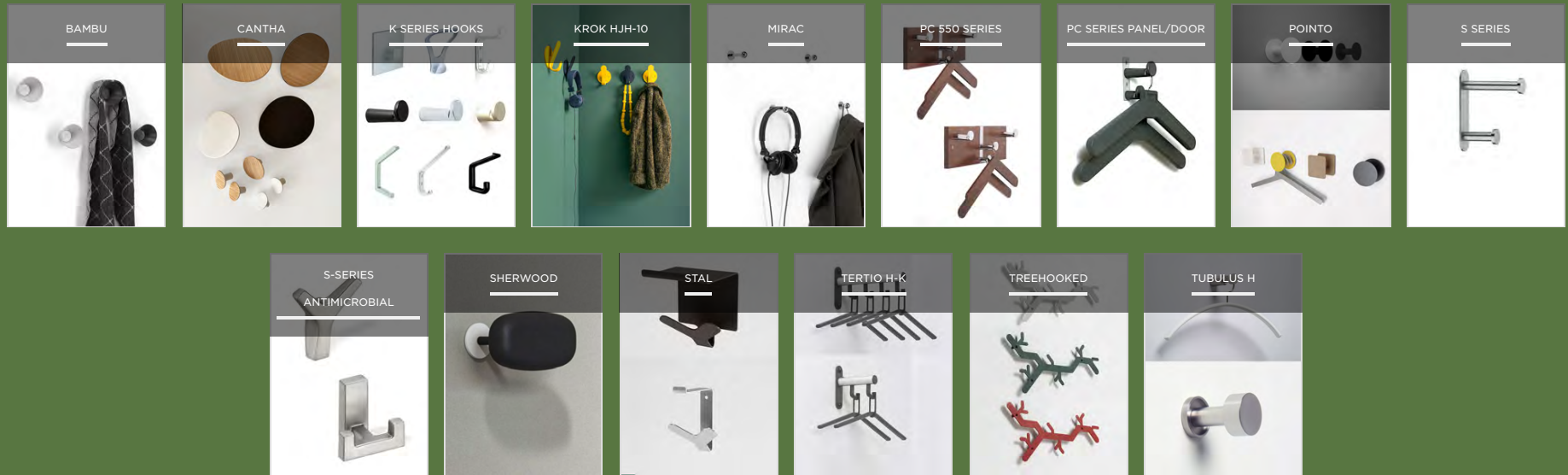

BAMBU

ADDITIONAL NOTES

Ships via UPS



LINE ART	MODEL	H	W	D	WEIGHT	DESCRIPTION	COLOR/FINISH	LIST PRICE
	BAMBU-06	1 3/8"	0	1 9/16"	1/4 lb.	Small ABS plastic hook.	Grey White Ral 9002 or Grey Ral 7022	33.00
	BAMBU-08	3 3/8"	0	1 9/16"	1/2 lb.	Large ABS plastic hook.	Grey White Ral 9002 or Grey Ral 7022	37.00

CANTHA

FINISH COLORS



Matte Grey Beige RAL 1019



Glossy Mustard RAL 1012



Matte White



Satin Black RAL 9011

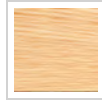

Matte Oak



ADDITIONAL NOTES

Ships via UPS

Due to the manufacturing process, slight variations may be present.

CANTHA is mounted using a threaded bolt that is screwed into the wall. Once in place, the hook is screwed into the bolt.

Sample chips available.

LINE ART	MODEL	H	W	D	WEIGHT	DESCRIPTION	COLOR/FINISH	LIST PRICE
	CANTHA-S	1 1/2"	1 9/16"	1 1/4"	1 lb.	Painted aluminum coat hook.	Matte White, Matte Grey Beige RAL 1019, Mustard Gloss RAL 1012, Satin Black RAL 9011	135.00
	CANTHA-SW	1 1/2"	1 9/16"	1 1/4"	1 lb.	Painted aluminum coat hook with oak veneer front plate.	Matte White, Matte Grey Beige RAL 1019, Mustard Gloss RAL 1012, Satin Black RAL 9011 Hook with Matte Oak front plate	185.00
	CANTHA-M	2 1/4"	2 3/8"	1 1/4"	1 lb.	Painted aluminum coat hook.	Matte White, Matte Grey Beige RAL 1019, Mustard Gloss RAL 1012, Satin Black RAL 9011	170.00
	CANTHA-MW	2 1/4"	2 3/8"	1 1/4"	1 lb.	Painted aluminum coat hook with oak veneer front plate.	Matte White, Matte Grey Beige RAL 1019, Mustard Gloss RAL 1012, Satin Black RAL 9011 Hook with Matte Oak front plate	225.00
	CANTHA-L	3 1/2"	3 15/16"	1 5/8"	1 lb.	Painted aluminum coat hook.	Matte White, Matte Grey Beige RAL 1019, Mustard Gloss RAL 1012, Satin Black RAL 9011	225.00
	CANTHA-LW	3 1/2"	3 15/16"	1 5/8"	1 lb.	Painted aluminum coat hook with oak veneer front plate.	Matte White, Matte Grey Beige RAL 1019, Mustard Gloss RAL 1012, Satin Black RAL 9011 Hook with Matte Oak front plate	295.00
	CANTHA-XL	5 1/4"	5 1/2"	1 5/8"	1 lb.	Painted aluminum coat hook.	Matte White, Matte Grey Beige RAL 1019, Mustard Gloss RAL 1012, Satin Black RAL 9011	250.00
	CANTHA-XLW	5 1/4"	5 1/2"	1 5/8"	1 lb.	Painted aluminum coat hook with oak veneer front plate.	Matte White, Matte Grey Beige RAL 1019, Mustard Gloss RAL 1012, Satin Black RAL 9011 Hook with Matte Oak front plate	305.00











K SERIES HOOKS













ADDITIONAL NOTES













Ships via UPS

Use Front Mount hooks when mounting directly into a wall, door or surface or when access to the back of the knob cannot be reached.



LINE ART	MODEL	H	W	D	WEIGHT	DESCRIPTION	COLOR/FINISH	LIST PRICE
	K-50C/FM	1 1/4"	1 1/4"	1 9/16"	1/4 lb.	Front mount zinc die cast knob	Polished Chrome	56.00
	K-50BC/FM	1 1/4"	1 1/4"	1 9/16"	1/4 lb.	Front mount zinc die cast knob	Brushed Chrome	58.00
	K-50N/FM	1 1/4"	1 1/4"	1 9/16"	1/4 lb.	Front mount zinc die cast knob, Powder coat finish	Black, White or Silver	52.00
	K-55C/FM	1 3/8"	1 3/8"	2 13/16"	1/2 lb.	Front mount zinc die cast knob	Polished Chrome	58.00
	K-55BC/FM	1 3/8"	1 3/8"	2 13/16"	1/2 lb.	Front mount zinc die cast knob	Brushed Chrome	61.00
	K-55N/FM	1 3/8"	1 3/8"	2 13/16"	1/2 lb.	Front mount zinc die cast knob, Powder coat finish	Black, White or Silver	57.00
	K-50/FMP	3"	3"	1 3/4"	1 lb.	Front mount die cast steel garment bag hook	Brushed Chrome or Polished Chrome	100.00
	K-73	3 1/4"	4"	2 1/2"	1/4 lb.	Triple prong hook for 3/4" square tubing	Charcoal Grey, Black, or Sandstone	30.00
	K-300C	4 9/16"	3 3/8"	2"	1 lb.	Front mount aluminum hook	Chrome	74.00
	K-300MS	4 9/16"	3 3/8"	2"	1 lb.	Front mount aluminum hook	Metallic Silver	66.00

	K-305MS	3 3/16"	3 3/16"	1 1/16"	1 lb.	Front mount aluminum hook	Metallic Silver	57.00
	K-310C	1 1/2"	3 1/2"	1 1/4"	1 lb.	Front mount zinc hook	Chrome	46.00
	K-310MS	1 1/2"	3 1/2"	1 1/4"	1 lb.	Front mount zinc hook	Metallic Silver	41.00
	K-315C	2 3/16"	2 1/2"	1 1/4"	1 lb.	Front mount zinc hook	Chrome	54.00
	K-320C	4"	3/8"	2 5/16"	1 lb.	Front mount aluminum hook	Chrome	39.00
	K-320MS	4"	3/8"	2 5/16"	1 lb.	Front mount aluminum hook	Metallic Silver	34.00
	K-2088	5"	2"	1 7/16"	1/4 lb.	Front mount Anodized Aluminum coat hook	Bright Silver	59.00
	K-2121	5"	1 1/8"	1 3/8"	1/4 lb.	Anodized Aluminum coat hook	Bright Silver	62.00
	K-2123	4 3/4"	2 7/8"	1 7/8"	1/2 lb.	Front mount Anodized Aluminum coat hook	Silver Grey	63.00
	K-2124	4 1/2"	2 3/4"	1 13/16"	1/2 lb.	Front mount Anodized Aluminum coat hook	Silver Grey	79.00
	K-2130	4 1/4"	2"	1 7/8"	1/4 lb.	Front mount Anodized Aluminum coat hook	Silver Grey	52.00
	K-2187A	4"	1 1/4"	1 1/4"	1/4 lb.	Anodized Aluminum coat hook	Titanium or Metallic Silver	61.00
	K-2202A	5 3/8"	1 7/16"	1 5/8"	1/4 lb.	Anodized Aluminum coat hook	Titanium or Metallic Silver	66.00

	K-15	3 11/16"	3/4"	3 1/8"	1/4 lb.	Nylon	Dark Grey	26.00
	K-21S	5 7/8"	7/8"	3 7/8"	1/4 lb.	Aluminum Hook	Silver Anodized	63.00
	K-21N	5 7/8"	7/8"	3 7/8"	1/4 lb.	Aluminum Hook, Powder coat finish	Black	61.00
	K-50C	1 1/4"	1 1/4"	1 9/16"	1/4 lb.	Zinc die cast knob	Polished Chrome	52.00
	K-50BC	1 1/4"	1 1/4"	1 9/16"	1/4 lb.	Zinc die cast knob	Brushed Chrome	57.00
	K-50N	1 1/4"	1 1/4"	1 9/16"	1/4 lb.	Zinc die cast knob, Powder coat finish	Black, White or Silver	49.00
	K-55C	1 3/8"	1 3/8"	2 13/16"	1/2 lb.	Zinc die cast knob	Polished Chrome	57.00
	K-55BC	1 3/8"	1 3/8"	2 13/16"	1/2 lb.	Zinc die cast knob	Brushed Chrome	59.00
	K-55N	1 3/8"	1 3/8"	2 13/16"	1/2 lb.	Zinc die cast knob, Powder coat finish	Black, White or Silver	56.00
	K-71C	2 1/4"	3/4"	1 3/4"	1/4 lb.	Steel hook	Chrome	12.00
	K-220S	3 13/16"	7/8"	3 3/4"	1/2 lb.	Aluminum hook with door stop	Silver Anodized	122.00
	K-230S	4 1/4"	7/8"	2 15/16"	1/2 lb.	Aluminum hook	Silver Anodized	86.00
	K41ST	5 1/8"	3/4"	4"	1/2 lb.	Stainless steel hook	Stainless steel	32.00

KROK HJH-10

ADDITIONAL NOTES

Ships via UPS

Sample chips available.



LINE ART	MODEL	H	W	D	WEIGHT	DESCRIPTION	COLOR/FINISH	LIST PRICE
	KROK-HJH-10	4 7/8"	3 1/8"	2 1/2"	1 lb.	Front mount coat hook with back plate and matching plastic hook	White 9310, Black 9311, Light Blue 5324, Dark Blue 5311, Dark Green 6309, Red 3309 or Yellow 1304	155.00

HOOK FINISH COLORS



Chromed

ADDITIONAL NOTES

Ships via UPS



LINE ART	MODEL	H	W	D	WEIGHT	DESCRIPTION	COLOR/FINISH	LIST PRICE
	MIRAC-HK1	1"	3/4"	1 3/8"	1/4 lb.	Single coat Hook	Chromed Brass	55.00
	MIRAC-HK2	1"	3/4"	2 3/8"	1/4 lb.	Single coat Hook	Chromed Brass	65.00



PC 550 SERIES

ADDITIONAL NOTES

Ships via UPS

TSCA Title VI Compliant.

Sample chips available.





LINE ART	MODEL	H	W	D	WEIGHT	DESCRIPTION	COLOR/FINISH	LIST PRICE
	PC-550	6"	18"	3 9/16"	5 lbs.	Executive wall costumer with three polished chrome knobs.	Oak, Walnut, Mahogany, Black or Victorian Cherry Laminate with polished chrome knobs, matching wood hangers	242.00

PC SERIES PANEL/DOOR

ADDITIONAL NOTES

Ships via UPS



LINE ART	MODEL	H	W	D	WEIGHT	DESCRIPTION	COLOR/FINISH	LIST PRICE
	PC-107H	4"	1"	3"	2 lbs.	Wall or door mounted costumer with 2 hangers	Charcoal Grey, Black	82.00
	PC-107H-CHROME	4"	1"	3"	2 lbs.	Wall or door mounted costumer with 2 hangers	Polished or Satin Chrome	111.00

POINTO

FINISH COLORS



Black



White



Mustard



Grey Beige

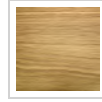





Matte Oak

ADDITIONAL NOTES

Ships via UPS

Sample chips available.



LINE ART	MODEL	H	W	D	WEIGHT	DESCRIPTION	COLOR/FINISH	LIST PRICE
	POINTO-10	3"	round	2 3/8"	1 lb.	Round epoxy coated steel coat hook.	Matte White RAL 9003, Matte Grey Beige RAL 1019, Mustard Gloss RAL 1012, Satin Black RAL 9011	160.00
	POINTO-10W	3"	round	2 3/8"	1 lb.	Round epoxy coated steel coat hook with laminated matte oak front plate.	Matte White RAL 9003, Matte Grey Beige RAL 1019, Mustard Gloss RAL 1012 or Satin Black RAL 9011 Hook with Matte Oak front plate	215.00
	POINTO-20	3"	3"	2 3/8"	1 lb.	Square epoxy coated steel coat hook.	Matte White RAL 9003, Matte Grey Beige RAL 1019, Mustard Gloss RAL 1012, Satin Black RAL 9011	160.00
	POINTO-20W	3"	3"	2 3/8"	1 lb.	Square epoxy coated steel coat hook with laminated matte oak front plate.	Matte White RAL 9003, Matte Grey Beige RAL 1019, Mustard Gloss RAL 1012 or Satin Black RAL 9011 Hook with Matte Oak front plate	215.00

S SERIES

ADDITIONAL NOTES

Ships via UPS

SCH-33905 longer hook measures 3 1/8"; shorter hook measures 1 3/4"



LINE ART	MODEL	H	W	D	WEIGHT	DESCRIPTION	COLOR/FINISH	LIST PRICE
	SCH-33905	4 1/16"	1"	3 1/4"	.50 lbs.	Double coat hook with back plate.	Brushed stainless steel	145.00

S-SERIES ANTIMICROBIAL

FINISH COLORS





Satin Nickel

ADDITIONAL NOTES

Ships via UPS



LINE ART	MODEL	H	W	D	WEIGHT	DESCRIPTION	COLOR/FINISH	LIST PRICE
	SCH-AM-Z327	2 9/16"	2 5/16"	1 1/16"	1 lb.	Zamak antimicrobial hook with concealed mounting.	Satin Nickel	105.00
	SCH-AM-Z313	2"	2"	1 5/8"	1 lb.	Zamak antimicrobial hook with concealed mounting.	Satin Nickel	105.00

SHERWOOD

ADDITIONAL NOTES

Ships via UPS



LINE ART	MODEL	H	W	D	WEIGHT	DESCRIPTION	COLOR/FINISH	LIST PRICE
	SW-M1	2 1/8"	3 7/8"	2 7/8"	1 lb.	Painted metal hook with one wood hook positioned horizontally.	Backplate and stem in White or Textured Black paint, with wood hook in Natural Beech, White or Black painted finish	81.00

STAL

FINISH COLORS



Sky White

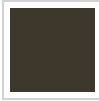

Mineral Bronze



Stainless Steel



ADDITIONAL NOTES

Ships via UPS.

Mounts directly to the wall with screws. Screws are included, mollies/toggle bolts not included.

Hook spacing allows for multiple units to be mounted side by side while maintaining consistent spacing.

Weight capacity of approximately 5lbs. per hook.

Stainless steel of STAL is Grade 430.

Sample chips available.





LINE ART	MODEL	H	W	D	WEIGHT	DESCRIPTION	COLOR/FINISH	LIST PRICE
	STAL-1N-P	5 3/16"	3 15/16"	3 11/16"	1 lb.	Painted steel wall mounted hook with 1 double pronged hook and a single hook above.	Sky White or Mineral Bronze	72.00
	STAL-1N-SS	5 3/16"	3 15/16"	3 11/16"	1 lb.	Stainless steel wall mounted hook with 1 double pronged hook and a single hook above.	Satin Stainless with Clear Coat	79.00
	STAL-1W-P	5 1/4"	4"	3 11/16"	3 lbs.	Painted steel wall mounted hook with 1 double pronged hook and a single hook above.	Sky White or Mineral Bronze	79.00
	STAL-1W-SS	5 1/4"	4"	3 11/16"	3 lbs.	Stainless steel wall mounted hook with 1 double pronged hook and a shelf above.	Satin Stainless with Clear Coat	88.00

TERTIO H-K

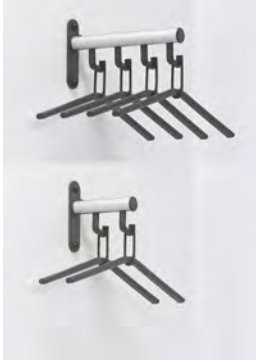
ADDITIONAL NOTES

Ships via UPS



LINE ART	MODEL	H	W	D	WEIGHT	DESCRIPTION	COLOR/FINISH	LIST PRICE
	T-H10K	11 13/16"	17 11/16"	3 15/16"	2 lb.	Wall mounted coat rack with one dark grey plastic coat hanger.	Dark Grey with Satin Aluminum.	240.00
	T-H16K	11 13/16"	17 11/16"	6 5/16"	3 lb.	Wall mounted coat rack with two dark grey plastic coat hangers.	Dark Grey with Satin Aluminum.	295.00
	T-H22K	11 13/16"	17 11/16"	8 11/16"	3 lb.	Wall mounted coat rack with three dark grey plastic coat hangers.	Dark Grey with Satin Aluminum.	360.00
	T-H28K	11 13/16"	17 11/16"	11 1/16"	3 lb.	Wall mounted coat rack with four dark grey plastic coat hangers.	Dark Grey with Satin Aluminum.	410.00

TREEHOOKED

ADDITIONAL NOTES

Ships via UPS

Sample chips available.





LINE ART	MODEL	H	W	D	WEIGHT	DESCRIPTION	COLOR/FINISH	LIST PRICE
	TREE-1	10 5/8"	23 1/4"	1 3/16"	5 lbs.	Wall mounted coat rack. Can be used individually or in groups.	White 9310, Black 9311, Light Blue 5324, Dark Blue 5311, Dark Green 6309, Red 3309, Yellow 1304 or Metallic Grey 9306	335.00

TUBULUS H

ADDITIONAL NOTES

Ships via UPS



LINE ART	MODEL	H	W	D	WEIGHT	DESCRIPTION	COLOR/FINISH	LIST PRICE
	TUB-H10	6 11/16"	17 15/16"	3 15/16"	2 lb.	Coat hook with hanger.	Brushed Stainless hook with front in Polished Stainless Steel, hanger in white or black.	430.00
	TUB-H	1"	1 5/16"	2 1/16"	1 lb.	Coat hook	Brushed Stainless with front in Polished Stainless Steel.	185.00

COAT HOOK STRIPS



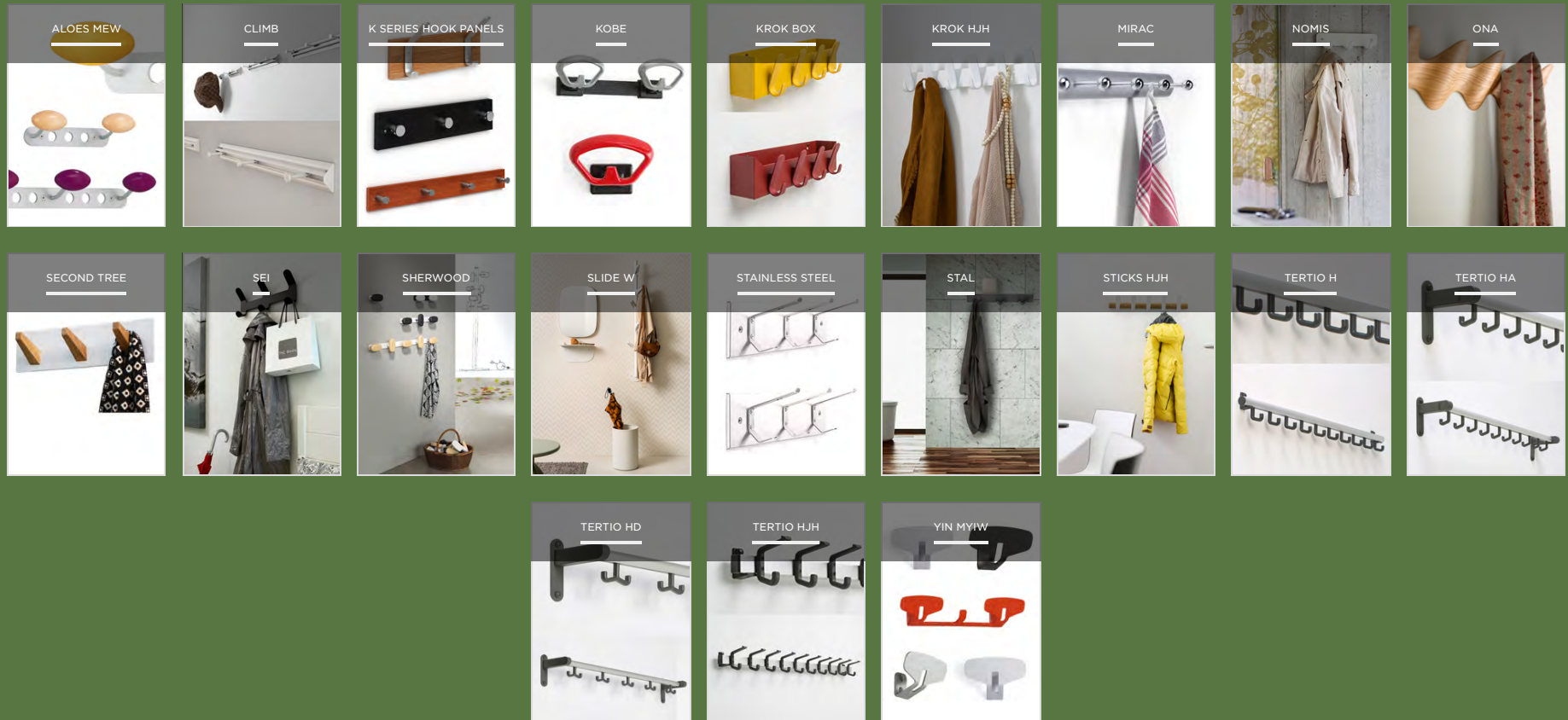

HOME → PRODUCTS → COAT HOOK STRIPS



ALOES MEW

ADDITIONAL NOTES

Ships via UPS





LINE ART	MODEL	H	W	D	WEIGHT	DESCRIPTION	COLOR/FINISH	LIST PRICE
	MEW-1	2 3/4"	3 1/4"	3 3/16"	1 lb.	Single coat hook	Strip in White, Sand, Silver or Black, knob in Beech, Wengue, White, Black or Green	59.00
	MEW-2	2 3/4"	9 7/8"	3 3/16"	2 lbs.	Hook strip with two coat hooks.	Strip in White, Sand, Silver or Black, knob in Beech, Wengue, White, Black or Green	152.00
	MEW-3	2 3/4"	16 9/16"	3 3/16"	3 lbs.	Hook strip with three coat hooks.	Strip in White, Sand, Silver or Black, knob in Beech, Wengue, White, Black or Green	187.00
	MEW-5	2 3/4"	29 15/16"	3 3/16"	5 lbs.	Hook strip with five coat hooks.	Strip in White, Sand, Silver or Black, knob in Beech, Wengue, White, Black or Green	265.00

CLIMB

ADDITIONAL NOTES

Ships via UPS



LINE ART	MODEL	H	W	D	WEIGHT	DESCRIPTION	COLOR/FINISH	LIST PRICE
	CLIMB-10	1 15/16"	1 3/4"	2 1/2"	1/4 lb.	Anodized aluminum hook rail with single hook.	Silver Matte Aluminum	145.00
	CLIMB-20	1 15/16"	7 5/8"	2 1/2"	1/2 lb.	Anodized aluminum hook rail with two hooks.	Silver Matte Aluminum	205.00
	CLIMB-30	1 15/16"	13 3/4"	2 1/2"	1 1/2 lbs.	Anodized aluminum hook rail with three hooks.	Silver Matte Aluminum	280.00
	CLIMB-40	1 15/16"	19 7/16"	2 1/2"	1 3/4 lbs.	Anodized aluminum hook rail with four hooks.	Silver Matte Aluminum	350.00
	CLIMB-70	1 15/16"	37 3/16"	2 1/2"	3 lbs.	Anodized aluminum hook rail with seven hooks.	Silver Matte Aluminum	560.00

K SERIES HOOK PANELS









ADDITIONAL NOTES











Ships via UPS

Specify K-Series hooks separately.

TSCA Title VI Compliant.



LINE ART	MODEL	H	W	D	WEIGHT	DESCRIPTION	COLOR/FINISH	LIST PRICE
	2K-21S	4"	12"	4 5/8"	3 lbs.	Hook Panel with two K-21S hooks	Silver Anodized Aluminum Hooks with Laminate Panel in Oak, Walnut, Featherstone Grey, Black, Victorian Cherry or Mahogany	165.00
	3K-21S	4"	18"	4 5/8"	4 lbs.	Hook Panel with three K-21S hooks	Silver Anodized Aluminum Hooks with Laminate Panel in Oak, Walnut, Featherstone Grey, Black, Victorian Cherry or Mahogany	235.00
	4K-21S	4"	34"	4 5/8"	5 lbs.	Hook Panel with four K-21S hooks	Silver Anodized Aluminum Hooks with Laminate Panel in Oak, Walnut, Featherstone Grey, Black, Victorian Cherry or Mahogany	305.00
	2K-50C	4"	12"	2 5/16"	3 lbs.	Hook Panel with two K-50C hooks	Polished Chrome Zinc Die Cast Hooks with Laminate Panel in Oak, Walnut, Featherstone Grey, Black, Victorian Cherry or Mahogany	140.00
	3K-50C	4"	18"	2 5/16"	4 lbs.	Hook Panel with three K-50C hooks	Polished Chrome Zinc Die Cast Hooks with Laminate Panel in Oak, Walnut, Featherstone Grey, Black, Victorian Cherry or Mahogany	208.00
	4K-50C	4"	34"	2 5/16"	5 lbs.	Hook Panel with four K-50C hooks	Polished Chrome Zinc Die Cast Hooks with Laminate Panel in Oak, Walnut, Featherstone Grey, Black, Victorian Cherry or Mahogany	265.00
	2K-50BC	4"	12"	2 5/16"	3 lbs.	Hook Panel with two K-50BC hooks	Brushed Chrome Zinc Die Cast Hooks with Laminate Panel in Oak, Walnut, Featherstone Grey, Black, Victorian Cherry or Mahogany	150.00
	3K-50BC	4"	18"	2 5/16"	4 lbs.	Hook Panel with three K-50BC hooks	Brushed Chrome Zinc Die Cast Hooks with Laminate Panel in Oak, Walnut, Featherstone Grey, Black, Victorian Cherry or Mahogany	222.00

	4K-50BC	4"	34"	2 5/16"	5 lbs.	Hook Panel with four K-50BC hooks	Brushed Chrome Zinc Die Cast Hooks with Laminate Panel in Oak, Walnut, Featherstone Grey, Black, Victorian Cherry or Mahogany	285.00
	2K-55C	4"	12"	3 9/16"	3 lbs.	Hook Panel with two K-55C hooks	Polished Chrome Zinc Die Cast Hooks with Laminate Panel in Oak, Walnut, Featherstone Grey, Black, Victorian Cherry or Mahogany	147.00
	3K-55C	4"	18"	3 9/16"	4 lbs.	Hook Panel with three K-55C hooks	Polished Chrome Zinc Die Cast Hooks with Laminate Panel in Oak, Walnut, Featherstone Grey, Black, Victorian Cherry or Mahogany	215.00
	4K-55C	4"	34"	3 9/16"	5 lbs.	Hook Panel with four K-55C hooks	Polished Chrome Zinc Die Cast Hooks with Laminate Panel in Oak, Walnut, Featherstone Grey, Black, Victorian Cherry or Mahogany	275.00
	2K-55BC	4"	12"	3 9/16"	3 lbs.	Hook Panel with two K-55BC hooks	Brushed Chrome Zinc Die Cast Hooks with Laminate Panel in Oak, Walnut, Featherstone Grey, Black, Victorian Cherry or Mahogany	152.00
	3K-55BC	4"	18"	3 9/16"	4 lbs.	Hook Panel with three K-55BC hooks	Brushed Chrome Zinc Die Cast Hooks with Laminate Panel in Oak, Walnut, Featherstone Grey, Black, Victorian Cherry or Mahogany	220.00
	4K-55BC	4"	34"	3 9/16"	5 lbs.	Hook Panel with four K-55BC hooks	Brushed Chrome Zinc Die Cast Hooks with Laminate Panel in Oak, Walnut, Featherstone Grey, Black, Victorian Cherry or Mahogany	290.00
	12" Panel For 2 hooks	4"	12"	3/4"	3 lbs. w/hooks	High pressure laminate panel	Oak, Walnut, Featherstone Grey, Black, Victorian Cherry or Mahogany	39.00
	18" Panel For 3 hooks	4"	18"	3/4"	4 lbs. w/hooks	High pressure laminate panel	Oak, Walnut, Featherstone Grey, Black, Victorian Cherry or Mahogany	53.00
	34" Panel For 4 hooks	4"	34"	3/4"	5 lbs. w/hooks	High pressure laminate panel	Oak, Walnut, Featherstone Grey, Black, Victorian Cherry or Mahogany	61.00

KOBE

ADDITIONAL NOTES

Ships via UPS.



LINE ART	MODEL	H	W	D	WEIGHT	DESCRIPTION	COLOR/FINISH	LIST PRICE
	KOBE-1	3 3/16"	3 13/16"	2 3/4"	1 lb.	Hook strip with single coat hook.	Black strip with ABS hook in White, Black, Silver or Red	58.00
	KOBE-2	3 3/16"	10 7/16"	2 3/4"	2 lb.	Hook strip with two coat hooks.	Black strip with ABS hook in White, Black, Silver or Red	83.00
	KOBE-3	3 3/16"	17 1/8"	2 3/4"	3 lb.	Hook strip with three coat hooks.	Black strip with ABS hook in White, Black, Silver or Red	126.00
	KOBE-5	3 3/16"	30 1/2"	2 3/4"	5 lb.	Hook strip with five coat hooks.	Black strip with ABS hook in White, Black, Silver or Red	170.00

KROK BOX

ADDITIONAL NOTES

Ships via UPS

Sample chips available.



LINE ART	MODEL	H	W	D	WEIGHT	DESCRIPTION	COLOR/FINISH	LIST PRICE
	KROK BOX	4 3/4"	19 3/4"	5 3/8"	5 lbs.	Textured painted steel storage box with four matching plastic coat hooks. Mounts to wall.	Black 9311, White 9310, Light Blue 5324, Dark Blue 5311, Red 3309, Yellow 1304 or Dark Green 6308	565.00

KROK HJH

ADDITIONAL NOTES

Ships via UPS

Sample chips available.



LINE ART	MODEL	H	W	D	WEIGHT	DESCRIPTION	COLOR/FINISH	LIST PRICE
<i>cb</i>	KROK HJH-30	4 7/8"	11 13/16"	2 1/4"	2 lbs.	Textured painted steel hook strip with two matching plastic coat hooks.	Black 9311, White 9310, Light Blue 5324, Dark Blue 5311, Red 3309, Yellow 1304 or Dark Green 6309	175.00
<i>cbcbcb</i>	KROK HJH-60	4 7/8"	23 5/8"	2 1/4"	4 lbs.	Textured painted steel hook strip with five matching plastic coat hooks.	Black 9311, White 9310, Light Blue 5324, Dark Blue 5311, Red 3309, Yellow 1304 or Dark Green 6309	290.00
<i>cbcbcbcbcb</i>	KROK HJH-90	4 7/8"	35 7/16"	2 1/4"	6 lbs.	Textured painted steel hook strip with eight matching plastic coat hooks.	Black 9311, White 9310, Light Blue 5324, Dark Blue 5311, Red 3309, Yellow 1304 or Dark Green 6309	395.00

RAIL FINISH COLORS



Aluminum
RAL 9006

HOOK FINISH COLORS



Chromed

ADDITIONAL NOTES

Ships via UPS

LINE ART	MODEL	H	W	D	WEIGHT	DESCRIPTION	COLOR/FINISH	LIST PRICE
	MIRAC-50	1 5/8"	19 11/16"	3 1/8"	2 lbs.	Aluminum hook rail with five chromed brass hooks.	Aluminum Ral 9006 rail with Chrome hooks	400.00





NOMIS

ADDITIONAL NOTES

Ships via UPS.



LINE ART	MODEL	H	W	D	WEIGHT	DESCRIPTION	COLOR/FINISH	LIST PRICE
	NOMIS-3	3 7/8"	14 3/4"	3 3/8"	3 lbs.	Painted metal hook strip with 3 integrated hooks and wood mounting backplate.	Black, White	395.00
	NOMIS-8	3 7/8"	39 3/8"	3 3/8"	8 lbs.	Painted metal hook strip with 8 integrated hooks and wood mounting backplate.	Black, White	590.00

ONA

FINISH COLORS



Oak

Walnut

White RAL 9002

ADDITIONAL NOTES

Ships via UPS

Ona mounts directly to the wall.

TSCA Title VI Compliant.



LINE ART	MODEL	H	W	D	WEIGHT	DESCRIPTION	COLOR/FINISH	LIST PRICE
	ONA	7 1/2"	38 3/16"	5 7/8"	5 lb.	Laminated wooden hook strip.	Oak, Grey White RAL 9002 or Walnut	760.00

SECOND TREE

FINISH COLORS



Matte Oak



Matte White
RAL 9003



Satin Black
RAL 9011



Textured
Forge Grey

ADDITIONAL NOTES

Ships via UPS.

SECOND TREE utilizes a wall mounted plate that the hook strip slides into.

Sample chips available.



LINE ART	MODEL	H	W	D	WEIGHT	DESCRIPTION	COLOR/FINISH	LIST PRICE
	SECOND TREE-3	5 1/8"	19"	4 3/16"	4 lbs.	Painted steel coat hook strip with three oak wood hooks.	Satin Black RAL 9011, Textured Forge Grey or Matte White RAL 9003 with Oak wood hooks.	440.00



SEI

ADDITIONAL NOTES

Ships via UPS

Sample chips available.



LINE ART	MODEL	H	W	D	WEIGHT	DESCRIPTION	COLOR/FINISH	LIST PRICE
	SEI-10	7 1/16"	9 13/16"	2 15/16"	4 lbs.	Hook strip with two epoxy coated steel hat and coat hooks	Black 9011, Metallic Grey 9006 or White 9010	450.00
	SEI-20	7 1/16"	17 11/16"	2 15/16"	6 lbs.	Hook strip with three epoxy coated steel hat and coat hooks.	Black 9011, Metallic Grey 9006 or White 9010	565.00



SHERWOOD

ADDITIONAL NOTES

Ships via UPS

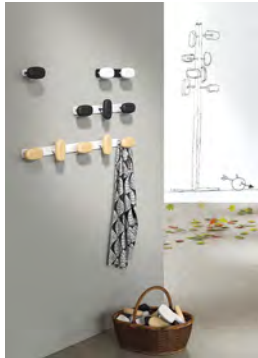
Hook positions are fixed.



LINE ART	MODEL	H	W	D	WEIGHT	DESCRIPTION	COLOR/FINISH	LIST PRICE
	SW-M2	2 1/8"	10 5/8"	2 7/8"	1 lb.	Painted metal hook strip with two wood hooks positioned horizontally.	Backplate and stem in White or Textured Black paint, with two wood hooks in Natural Beech, White or Black painted finish	122.00
	SW-M3	3 7/8"	17 5/16"	2 7/8"	2 lbs.	Painted metal hook strip with three wood hooks. Center hook is positioned vertically, two outer hooks are positioned horizontally.	Backplate and stem in White or Textured Black paint with three wood hooks in Natural Beech, White or Black painted finish.	185.00
	SW-M5	3 7/8"	30 5/8"	2 7/8"	4 lbs.	Painted metal hook strip with five wood hooks. Hooks alternate between horizontal and vertical positioning.	Backplate and stem in White or Textured Black paint with five wood hooks in Natural Beech, White or Black painted finish.	295.00

SLIDE W

ADDITIONAL NOTES

Ships via UPS

Hooks can be adjusted from side to side and up and down.

Sample chips available.







LINE ART	MODEL	H	W	D	WEIGHT	DESCRIPTION	COLOR/FINISH	LIST PRICE
	SLIDE W2	50"	4 11/16"	7 3/4"	8 lbs.	Wall mounted coat tree with painted metal base and post with 5 white plastic hooks.	Base and post in White textured paint	525.00

STAINLESS STEEL

ADDITIONAL NOTES

Ships via UPS



LINE ART	MODEL	H	W	D	WEIGHT	DESCRIPTION	COLOR/FINISH	LIST PRICE
	K-41ST	5 1/8"	3/4"	4"	1/2 lb.	Single hook	Stainless Steel	32.00
	2K-41ST	4"	12"	4 1/4"	3 lbs.	Two hook panel	Stainless Steel	96.00
	3K-41ST	4"	18"	4 1/4"	4 lbs.	Three hook panel	Stainless Steel	134.00
	6K-41ST	4"	36"	4 1/4"	6 lbs.	Six hook panel	Stainless Steel	197.00

FINISH COLORS



Sky White



Mineral Bronze



Stainless Steel

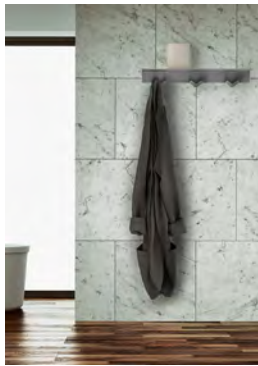

ADDITIONAL NOTES

Ships via UPS.

Mounts directly to the wall with screws. Screws are included, mollies/toggle bolts not included.

Hook spacing allows for multiple units to be mounted side by side while maintaining consistent spacing.

Weight capacity of approximately 5lbs. per hook.

Stainless steel of STAL is Grade 430.

Sample chips available.

LINE ART	MODEL	H	W	D	WEIGHT	DESCRIPTION	COLOR/FINISH	LIST PRICE
	STAL-1N-P	5 3/16"	3 15/16"	3 11/16"	1 lb.	Painted steel wall mounted hook with 1 double pronged hook and a single hook above.	Sky White or Mineral Bronze	72.00
	STAL-1N-SS	5 3/16"	3 15/16"	3 11/16"	1 lb.	Stainless steel wall mounted hook with 1 double pronged hook and a single hook above.	Satin Stainless with Clear Coat	79.00
	STAL-1W-P	5 1/4"	4"	3 11/16"	3 lbs.	Painted steel wall mounted hook with 1 double pronged hook and a single shelf above.	Sky White or Mineral Bronze	79.00
	STAL-1W-SS	5 1/4"	4"	3 11/16"	3 lbs.	Stainless steel wall mounted hook with 1 double pronged hook and a single shelf above.	Satin Stainless with Clear Coat	88.00
	STAL-3-P	5 1/4"	30"	3 11/16"	5 lbs.	Painted steel wall mounted hook strip with 3 double pronged hooks and a shelf above.	Sky White or Mineral Bronze	182.00
	STAL-3-SS	5 1/4"	30"	3 11/16"	5 lbs.	Stainless steel wall mounted hook strip with 3 double pronged hooks and a shelf above.	Satin Stainless with Clear Coat	238.00
	STAL-4-P	5 1/4"	40"	3 11/16"	6 lbs.	Painted steel wall mounted hook strip with 4 double pronged hooks and a shelf above.	Sky White or Mineral Bronze	202.00
	STAL-4-SS	5 1/4"	40"	3 11/16"	6 lbs.	Stainless steel wall mounted hook strip with 4 double pronged hooks and a shelf above.	Satin Stainless with Clear Coat	262.00

STAL-5-P	5 1/4"	50"	3 11/16"	7 lbs.	Painted steel wall mounted hook strip with 5 double pronged hooks and a shelf above.	Sky White or Mineral Bronze	285.00
STAL-5-SS	5 1/4"	50"	3 11/16"	7 lbs.	Stainless steel wall mounted hook strip with 5 double pronged hooks and a shelf above.	Satin Stainless with Clear Coat	335.00

STICKS HJH

ADDITIONAL NOTES

Ships via UPS







LINE ART	MODEL	H	W	D	WEIGHT	DESCRIPTION	COLOR/FINISH	LIST PRICE
	STICKS-HJH-30	4 15/16"	11 13/16"	2 15/16"	1 lb.	Hook rail with two white plastic hat and coat hooks.	Varnished Natural Oak rail	320.00
	STICKS-HJH-60	4 15/16"	23 5/8"	2 15/16"	2 lbs.	Hook rail with five white plastic hat and coat hooks.	Varnished Natural Oak rail	490.00
	STICKS-HJH-90	4 15/16"	35 7/16"	2 15/16"	3 lbs.	Hook rail with eight white plastic hat and coat hooks.	Varnished Natural Oak rail	645.00

TERTIO H

ADDITIONAL NOTES

Ships via UPS





LINE ART	MODEL	H	W	D	WEIGHT	DESCRIPTION	COLOR/FINISH	LIST PRICE
	T-H-30	3 1/8"	11 13/16"	3 1/8"	2 lbs.	Round hook rail with three grey plastic hooks.	Anodized Aluminum strip, Dark Grey supports	125.00
	T-H-60	3 1/8"	23 5/8"	3 1/8"	3 lbs.	Round hook rail with six grey plastic hooks.	Anodized Aluminum strip, Dark Grey supports	210.00
	T-H-90	3 1/8"	35 7/16"	3 1/8"	3 lbs.	Round hook rail with nine grey plastic hooks.	Anodized Aluminum strip, Dark Grey supports	295.00
	T-H-120	3 1/8"	47 1/4"	3 1/8"	4 lbs.	Round hook rail with twelve grey plastic hooks.	Anodized Aluminum strip, Dark Grey supports	365.00

TERTIO HA

ADDITIONAL NOTES

Ships via UPS



LINE ART	MODEL	H	W	D	WEIGHT	DESCRIPTION	COLOR/FINISH	LIST PRICE
	T-HA-60	6 5/16"	23 5/8"	5 7/8"	5 lbs.	Hook rail with six grey plastic hooks.	Anodized Aluminum strip, Dark Grey supports	310.00
	T-HA-90	6 5/16"	35 7/16"	5 7/8"	7 lbs.	Hook rail with nine grey plastic hooks.	Anodized Aluminum strip, Dark Grey supports	360.00
	T-HA-120	6 5/16"	47 1/4"	5 7/8"	8 lbs.	Hook rail with twelve grey plastic hooks.	Anodized Aluminum strip, Dark Grey supports	410.00

TERTIO HD

ADDITIONAL NOTES

Ships via UPS



LINE ART	MODEL	H	W	D	WEIGHT	DESCRIPTION	COLOR/FINISH	LIST PRICE
	T-HD-60	6 5/16"	23 5/8"	5 7/8"	5 lbs.	Hook rail with three double prong grey plastic hooks.	Anodized Aluminum strip, Dark Grey supports	310.00
	T-HD-90	6 5/16"	35 7/16"	5 7/8"	7 lbs.	Hook rail with four double prong grey plastic hooks.	Anodized Aluminum strip, Dark Grey supports	360.00
	T-HD-120	6 5/16"	47 1/4"	5 7/8"	8 lbs.	Hook rail with six double prong grey plastic hooks.	Anodized Aluminum strip, Dark Grey supports	410.00

TERTIO HJH

ADDITIONAL NOTES

Ships via UPS





LINE ART	MODEL	H	W	D	WEIGHT	DESCRIPTION	COLOR/FINISH	LIST PRICE
	T-HJH-30	3 3/4"	11 13/16"	4 3/4"	2 lbs.	Hook rail with three grey plastic hat & coat hooks.	Anodized Aluminum strip, Dark Grey supports	130.00
	T-HJH-60	3 3/4"	23 5/8"	4 3/4"	3 lbs.	Hook rail with six grey plastic hat & coat hooks.	Anodized Aluminum strip, Dark Grey supports	260.00
	T-HJH-90	3 3/4"	35 7/16"	4 3/4"	4 lbs.	Hook rail with nine grey plastic hat & coat hooks.	Anodized Aluminum strip, Dark Grey supports	360.00
	T-HJH-120	3 3/4"	47 1/4"	4 3/4"	5 lbs.	Hook rail with twelve grey plastic hat & coat hooks.	Anodized Aluminum strip, Dark Grey supports	430.00

YIN MYIW

ADDITIONAL NOTES

Ships via UPS

Sample chips available.

LINE ART	MODEL	H	W	D	WEIGHT	DESCRIPTION	COLOR/FINISH	LIST PRICE
	MYIW-1	2 1/4"	3"	2"	2 lbs.	Hook strip with single coat hook.	White, Sand, Clay, Silver, Black, Red, or Chocolate	108.00
	MYIW-2	2 1/4"	9 13/16"	2"	3 lbs.	Hook strip with two coat hooks.	White, Sand, Clay, Silver, Black, Red, or Chocolate	143.00
	MYIW-3	2 1/4"	15 9/16"	2"	4 lbs.	Hook strip with three coat hooks.	White, Sand, Clay, Silver, Black, Red, or Chocolate	181.00
	MYIW-5	2 1/4"	32"	2"	6 lbs.	Hook strip with five coat hooks.	White, Sand, Clay, Silver, Black, Red, or Chocolate	268.00

COAT RACKS

HOME → PRODUCTS → COAT RACKS



FRAME

FINISH COLORS



Textured Black

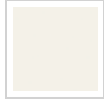

Textured White

PANEL FINISH COLORS



Black



Dark Green

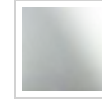

Mirror



Pinboard

ADDITIONAL NOTES

Ships via common carrier.

FRAME models with melamine, mirror or pinboard panel must be anchored to the wall for stability. Hardware provided.



Pair FRAME with TUBULUS, UNIVERSUM or any standard 1 1/2" open hook hangers.

Assembly required.

Sample chips available.



LINE ART	MODEL	H	W	D	WEIGHT	DESCRIPTION	COLOR/FINISH	LIST PRICE
	FRAME-DV47	66 15/16"	17 3/4"	18 1/2"	23 lbs.	Painted steel coat rack.	Textured Black or Textured White	1,440.00
	FRAME-DV47-P	66 15/16"	17 3/4"	18 1/2"	40 lbs.	Painted steel coat rack with melamine panel. Wall mount required for stability.	Textured Black or Textured White with Black or Dark Green melamine panel	2,160.00
	FRAME-DV47-S	66 15/16"	17 3/4"	18 1/2"	52 lbs.	Painted steel coat rack with mirror. Wall mount required for stability.	Textured Black or Textured White	2,645.00
	FRAME-DV47-B	66 15/16"	17 3/4"	18 1/2"	46 lbs.	Painted steel coat rack with pinboard panel. Wall mount required for stability.	Textured Black or Textured White with cork colored pinboard panel	3,220.00
	FRAME-DV89	66 15/16"	17 3/4"	35 1/16"	25 lbs.	Painted steel coat rack.	Textured Black or Textured White	1,590.00
	FRAME-DV89-P	66 15/16"	17 3/4"	35 1/16"	43 lbs.	Painted steel coat rack with melamine panel. Wall mount required for stability.	Textured Black or Textured White with Black or Dark Green melamine panel	2,305.00



	FRAME-DV89-S	66 15/16"	17 3/4"	35 1/16"	54 lbs.	Painted steel coat rack with mirror. Wall mount required for stability.	Textured Black or Textured White	2,695.00
	FRAME-DV89-B	66 15/16"	17 3/4"	35 1/16"	49 lbs.	Painted steel coat rack with pinboard panel. Wall mount required for stability.	Textured Black or Textured White with cork colored pinboard panel	3,350.00
	FRAME-HK-DBL	3 5/8"	1"	1 7/8"	1/2 lb.	Set of 3 double sided hooks for use with FRAME coat racks.	Textured Black	150.00

TERTIO

ADDITIONAL NOTES

Ships via common carrier.







LINE ART	MODEL	H	W	D	WEIGHT	DESCRIPTION	COLOR/FINISH	LIST PRICE
	T-EV/K-100	66 15/16"	39 3/8"	23 5/8"	39 lbs.	Single Sided Floor Rack-Powder-coated frames with satin anodized aluminum shelf, includes 10 hangers	Dark Grey with Satin Aluminum	2,455.00
	T-DV/K-100	66 15/16"	39 3/8"	40 3/16"	47 lbs.	Double Sided Floor Rack-Powder-coated frames with satin anodized aluminum shelf, includes 20 hangers	Dark Grey with Satin Aluminum	3,395.00
	T-UMB-100	19 11/16"	39 3/8"	5 9/16"	15 lbs.	Umbrella Stand which integrates into the EV model complete with drip tray and rubber mat.	Satin Anodized Aluminum	885.00

TERTIO W/K

ADDITIONAL NOTES

Ships via UPS





LINE ART	MODEL	H	W	D	WEIGHT	DESCRIPTION	COLOR/FINISH	LIST PRICE
	T-W/K-60	11 13/16"	23 5/8"	21 1/4"	7 lbs.	Wall rack with powder coated brackets and satin anodized aluminum shelf. Includes 6 hangers	Dark Grey with Satin Aluminum	825.00
	T-W/K-100	11 13/16"	39 3/8"	21 1/4"	12 lbs.	Wall rack with powder coated brackets and satin anodized aluminum shelf. Includes 10 hangers	Dark Grey with Satin Aluminum	1,160.00
	T-W/K-120	11 13/16"	47 1/4"	21 1/4"	14 lbs.	Wall rack with powder coated brackets and satin anodized aluminum shelf. Includes 12 hangers	Dark Grey with Satin Aluminum	1,345.00
	T-W/K-150	11 13/16"	59 1/16"	21 1/4"	17 lbs.	Wall rack with powder coated brackets and satin anodized aluminum shelf. Includes 14 hangers	Dark Grey with Satin Aluminum	1,745.00
	T-W/K-180	11 13/16"	70 7/8"	21 1/4"	21 lbs.	Wall rack with powder coated brackets and satin anodized aluminum shelf. Includes 18 hangers	Dark Grey with Satin Aluminum	2,005.00

TERTIO W2

ADDITIONAL NOTES

Ships via UPS



LINE ART	MODEL	H	W	D	WEIGHT	DESCRIPTION	COLOR/FINISH	LIST PRICE
	T-W2-60	6 5/16"	23 5/8"	13"	7 lbs.	Hook style wall rack with powder coated brackets and satin anodized aluminum shelf. Includes 11 dark grey plastic hooks.	Dark Grey with Satin Aluminum	645.00
	T-W2-90	6 5/16"	35 7/16"	13"	10 lbs.	Hook style wall rack with powder coated brackets and satin anodized aluminum shelf. Includes 17 dark grey plastic hooks.	Dark Grey with Satin Aluminum	860.00
	T-W2-120	6 5/16"	47 1/4"	13"	14 lbs.	Hook style wall rack with powder coated brackets and satin anodized aluminum shelf. Includes 23 dark grey plastic hooks.	Dark Grey with Satin Aluminum	1,045.00

CUSTOM LENGTH COAT RACKS

HOME → PRODUCTS → CUSTOM LENGTH COAT RACKS



RIDGE HANGER FLOOR RACK (SHA)

FRAME FINISH COLORS



Medium Grey Black

Sandstone

HOW TO ORDER



Determine Freestanding Rack Width
#1
Select Shelf Tube Material/Color
#2
Select Frame Color
#3

Example Order: SHA5-ST + 2x SHA3-ST-AO in Medium Grey - 11' wide SHA Single Sided Freestanding Coat Rack in Medium Grey (standard unit + 2 add-on units).

SHELF TUBE FINISH COLORS



Medium Grey Black

Sandstone

Anodized Aluminum

ADDITIONAL NOTES

ADD-ON MODELS

Customize your configuration by starting with a standard Ridge model & combining with add-on ("-AO") Ridge units to achieve desired width.



ADDITIONAL NOTES

Ships UPS where possible, otherwise Common Carrier is used.

SHA units accept standard 1-1/2" open hangers, CL closed loop hangers or R1.5 receptacles with MG17PP T-Top or MG17B ball top hangers.













Hangers not included. A maximum of 5 hangers per foot are recommended on all SHA floor racks. Some hanger bar deflection is possible on 5ft.+ units.

Longer lengths are available by combining basic and add-on units, which share a common upright. Per the product dimensions, add-on units are 1" narrower than standard units because they share an upright with adjacent standard units.

Sample chips available.

Submittal drawings are available upon request.



LINE ART	MODEL	H	W	D	WEIGHT	DESCRIPTION	COLOR/FINISH	LIST PRICE
	SHA3-ST	61"	36"	18 3/8"	36 lbs.	Hanger style 3 ft single sided floor rack in powder coated steel with 1" o.d. stainless steel hanger rod	Medium Gray, Sandstone or Black	604.00
	SHA3-ST-AO	61"	35"	18 3/8"	23 lbs.	Hanger style 3 ft add-on single sided floor rack in powder coated steel with 1" o.d. stainless steel hanger rod	Medium Gray, Sandstone or Black	493.00
	SHA4-ST	61"	48"	18 3/8"	40 lbs.	Hanger style 4 ft single sided floor rack in powder coated steel with 1" o.d. stainless steel hanger rod	Medium Gray, Sandstone or Black	643.00
	SHA4-ST-AO	61"	47"	18 3/8"	26 lbs.	Hanger style 4 ft add on single sided floor rack in powder coated steel with 1" o.d. stainless steel hanger rod	Medium Gray, Sandstone or Black	528.00
	SHA5-ST	61"	60"	18 3/8"	45 lbs.	Hanger style 5 ft single sided floor rack in powder coated steel with 1" o.d. stainless steel hanger rod	Medium Gray, Sandstone or Black	700.00
	SHA5-ST-AO	61"	59"	18 3/8"	31 lbs.	Hanger style 5 ft add on single sided floor rack in powder coated steel with 1" o.d. stainless steel hanger rod	Medium Gray, Sandstone or Black	576.00
	SHA3-AL	61"	36"	18 3/8"	36 lbs.	Hanger style 3 ft single sided floor rack in aluminum with 1" o.d. stainless steel hanger rod	Frames in Medium Grey, Sandstone or Black; Shelf Tubes in Anodized Aluminum	684.00
	SHA3-AL-AO	61"	35"	18 3/8"	23 lbs.	Hanger style 3 ft add on single sided floor rack in aluminum with 1" o.d. stainless steel hanger rod	Frames in Medium Grey, Sandstone or Black; Shelf Tubes in Anodized Aluminum	557.00
	SHA4-AL	61"	48"	18 3/8"	40 lbs.	Hanger style 4 ft single sided floor rack in aluminum with 1" o.d. stainless steel hanger rod	Frames in Medium Grey, Sandstone or Black; Shelf Tubes in Anodized Aluminum	741.00
	SHA4-AL-AO	61"	47"	18 3/8"	26 lbs.	Hanger style 4 ft add on single sided floor rack in aluminum constructin with 1" o.d. stainless steel hanger rod	Frames in Medium Grey, Sandstone or Black; Shelf Tubes in Anodized Aluminum	606.00
	SHA5-AL	61"	60"	18 3/8"	45 lbs.	Hanger style 5 ft single sided floor rack in aluminum with 1" o.d. stainless steel hanger rod	Frames in Medium Grey, Sandstone or Black; Shelf Tubes in Anodized Aluminum	806.00
	SHA5-AL-AO	61"	59"	18 3/8"	31 lbs.	Hanger style 5 ft add on single sided floor rack in aluminum with 1" o.d. stainless steel hanger rod	Frames in Medium Grey, Sandstone or Black; Shelf Tubes in Anodized Aluminum	655.00

RIDGE DOUBLE HANGER FLOOR RACK (DHA)

FRAME FINISH COLORS



Medium Grey Black

Sandstone

SHELF TUBE FINISH COLORS



Medium Grey Black

Sandstone

Anodized
Aluminum

HOW TO ORDER



Determine Freestanding Rack Width
#1
Select Shelf Tube Material/Color
#2
Select Frame Color
#3

Example Order: DHA4-AL + 2x DHA3-AL-AO in Black - 10' wide DHA Double Sided Freestanding Coat Rack in Black with Anodized Aluminum Shelf Tubes (standard unit + 2 add-on units).

ADDITIONAL NOTES

ADD-ON MODELS

Customize your configuration by starting with a standard Ridge model & combining with add-on ("-AO") Ridge units to achieve desired width.



ADDITIONAL NOTES

Ships via common carrier.

DHA units accept standard 1-1/2" open hangers, CL closed loop hangers or R1.5 receptacles with MG17PP T-Top or MG17B ball top hangers.

Hangers not included. A maximum of 5 hangers per foot are recommended on all DHA floor racks. Some hanger bar deflection is possible on 5ft.+ units. Hangers not included.













Longer lengths are available by combining basic and add-on units, which share a common upright. Per the product dimensions, add-on units are 1" narrower than standard units because they share an upright with adjacent standard units.

Caster base assembly can be added for mobility Model CBAxx. Includes set of four double wheel locking casters with spacer bar and shock bracing.

Sample chips available.

Submittal drawings are available upon request.



LINE ART	MODEL	H	W	D	WEIGHT	DESCRIPTION	COLOR/FINISH	LIST PRICE
	DHA3-ST	61"	36"	27 3/8"	47 lbs.	Hanger style 3 ft double sided floor rack in powder coated steel with 1" o.d. stainless steel hanger rod	Medium Gray, Sandstone or Black	931.00
	DHA3-ST-AO	61"	35"	27 3/8"	35 lbs.	Hanger style 3 ft add on double sided floor rack in powder coated steel with 1" o.d stainless steel hanger rod	Medium Gray, Sandstone or Black	787.00
	DHA4-ST	61"	48"	27 3/8"	53 lbs.	Hanger style 4 ft double sided floor rack in powder coated steel with 1" o.d. stainless steel hanger rod	Medium Gray, Sandstone or Black	995.00
	DHA4-ST-AO	61"	47"	27 3/8"	41 lbs.	Hanger style 4 ft add on double sided floor rack in powder coated steel with 1" o.d. stainless steel hanger rod	Medium Gray, Sandstone or Black	843.00
	DHA5-ST	61"	60"	27 3/8"	59 lbs.	Hanger style 5 ft double sided floor rack in powder coated steel with 1" o.d. stainless steel hanger rod	Medium Gray, Sandstone or Black	1,073.00
	DHA5-ST-AO	61"	59"	27 3/8"	47 lbs.	Hanger style 5 ft add on double sided floor rack in powder coated steel with 1" o.d stainless steel hanger rod	Medium Gray, Sandstone or Black	923.00
	DHA3-AL	61"	36"	27 3/8"	47 lbs.	Hanger style 3 ft double sided floor rack in aluminum with 1" o.d. stainless steel hanger rod	Frames in Medium Grey, Sandstone or Black; Shelf Tubes in Anodized Aluminum	1,073.00
	DHA3-AL-AO	61"	35"	27 3/8"	35 lbs.	Hanger style 3 ft add on double sided floor rack in aluminum with 1" o.d. stainless steel hanger rod	Frames in Medium Grey, Sandstone or Black; Shelf Tubes in Anodized Aluminum	908.00
	DHA4-AL	61"	48"	27 3/8"	53 lbs.	Hanger style 4 ft double sided floor rack in aluminum with 1" o.d. stainless steel hanger rod	Frames in Medium Grey, Sandstone or Black; Shelf Tubes in Anodized Aluminum	1,152.00
	DHA4-AL-AO	61"	47"	27 3/8"	41 lbs.	Hanger style 4 ft add on double sided floor rack in aluminum with 1" o.d. stainless steel hanger rod	Frames in Medium Grey, Sandstone or Black; Shelf Tubes in Anodized Aluminum	964.00
	DHA5-AL	61"	60"	27 3/8"	59 lbs.	Hanger style 5 ft double sided floor rack in aluminum with 1" o.d. stainless steel hanger rod	Frames in Medium Grey, Sandstone or Black; Shelf Tubes in Anodized Aluminum	1,228.00
	DHA5-AL-AO	61"	59"	27 3/8"	47 lbs.	Hanger style 5 ft add on double sided floor rack in aluminum with 1" o.d. stainless steel hanger rod	Frames in Medium Grey, Sandstone or Black; Shelf Tubes in Anodized Aluminum	1,065.00

CBA-36D	Add 3" to height of rack	34"	N/A	9 lbs.	Set of four 2 1/2" double wheel locking casters with Spacer Bar and Shock Bracing. For use with DHA3 units.	Medium Grey, Sandstone or Black with Black Casters	175.00
CBA-48D	Add 3" to height of rack	46"	N/A	10 lbs.	Set of four 2 1/2" double wheel locking casters with Spacer Bar and Shock Bracing. For use with DHA4 units.	Medium Grey, Sandstone or Black with Black Casters	186.00
CBA-60D	Add 3" to height of rack	58"	N/A	11 lbs.	Set of four 2 1/2" double wheel locking casters with Spacer Bar and Shock Bracing. For use with DHA5 units.	Medium Grey, Sandstone or Black with Black Casters	204.00

RIDGE HOOK FLOOR RACK (SKA)

FRAME FINISH COLORS



Medium Grey Black Sandstone

HOOK FINISH COLORS



Charcoal Grey Sandstone Black

SHELF TUBE FINISH COLORS



Medium Grey Black Sandstone Anodized Aluminum

HOW TO ORDER



#1 Determine Freestanding Rack Width
#2 Select Shelf Tube Material/Color
#3 Select Frame & Hook Color

Example Order: SKA3-ST + 2x SKA3-ST-AO in Medium Grey with Charcoal Grey Hooks - 9' wide SKA Single Sided Freestanding Coat Rack in Medium Grey with Charcoal Grey Hooks (standard unit + 2 add-on units).

ADDITIONAL NOTES

ADD-ON MODELS

Customize your configuration by starting with a standard Ridge model & combining with add-on ("-AO") Ridge units to achieve desired width.

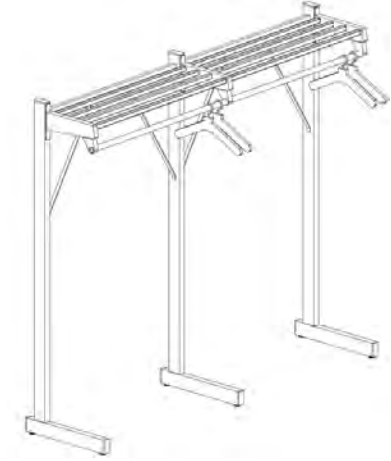

ADDITIONAL NOTES

Ships UPS where possible, otherwise Common Carrier is used.



Triple prong hooks secured to 2nd and 4th tubes from the front.









Longer lengths are available by combining basic and add-on units, which share a common upright. Per the product dimensions, add-on units are 1" narrower than standard units because they share an upright with adjacent standard units.

Sample chips available.

Submittal drawings are available upon request.



LINE ART	MODEL	H	W	D	WEIGHT	DESCRIPTION	COLOR/FINISH	LIST PRICE
	SKA3-ST	61"	36"	18 3/8"	38 lbs.	Hook style 3 ft single sided floor rack in powder coated steel with six K73 powder coated steel triple prong hooks	Frame & Shelves in Medium Grey, Sandstone or Black; Hooks in Charcoal Grey, Sandstone or Black	675.00
	SKA3-ST-AO	61"	35"	18 3/8"	25 lbs.	Hook style 3 ft add on single sided floor rack in powder coated steel with six K73 powder coated steel triple prong hooks	Frame & Shelves in Medium Grey, Sandstone or Black; Hooks in Charcoal Grey, Sandstone or Black	542.00
	SKA4-ST	61"	48"	18 3/8"	42 lbs.	Hook style 4 ft single sided floor rack in powder coated steel with eight K73 powder coated steel triple prong hooks	Frame & Shelves in Medium Grey, Sandstone or Black; Hooks in Charcoal Grey, Sandstone or Black	714.00

	SKA4-ST-AO	61"	47"	18 3/8"	28 lbs.	Hook style 4 ft add on single sided floor rack in powder coated steel with eight K73 powder coated steel triple prong hooks	Frame & Shelves in Medium Grey, Sandstone or Black; Hooks in Charcoal Grey, Sandstone or Black	587.00
	SKA5-ST	61"	60"	18 3/8"	47 lbs.	Hook style 5 ft single sided floor rack in powder coated steel with twelve K73 powder coated steel triple prong hooks	Frame & Shelves in Medium Grey, Sandstone or Black; Hooks in Charcoal Grey, Sandstone or Black	763.00
	SKA5-ST-AO	61"	59"	18 3/8"	34 lbs.	Hook style 5 ft add on single sided floor rack in powder coated steel with twelve K73 powder coated steel triple prong hooks	Frame & Shelves in Medium Grey, Sandstone or Black; Hooks in Charcoal Grey, Sandstone or Black	642.00
	SKA3-AL	61"	36"	18 3/8"	36 lbs.	Hook style 3 ft single sided floor rack with Anodized Aluminum shelf tubes and painted steel frame with six K73 powder coated steel triple prong hooks	Frame in Medium Gray, Sandstone or Black; Hooks in Charcoal Grey, Sandstone or Black; Shelf Tubes in Anodized Aluminum	763.00
	SKA3-AL-AO	61"	35"	18 3/8"	23 lbs.	Hook style 3 ft add on single sided floor rack with Anodized Aluminum shelf tubes and painted steel frame with six K73 powder coated steel triple prong hooks	Frame in Medium Gray, Sandstone or Black; Hooks in Charcoal Grey, Sandstone or Black; Shelf Tubes in Anodized Aluminum	626.00
	SKA4-AL	61"	48"	18 3/8"	40 lbs.	Hook style 4 ft single sided floor rack with Anodized Aluminum shelf tubes and painted steel frame with eight K73 powder coated steel triple prong hooks	Frame in Medium Gray, Sandstone or Black; Hooks in Charcoal Grey, Sandstone or Black; Shelf Tubes in Anodized Aluminum	822.00
	SKA4-AL-AO	61"	47"	18 3/8"	26 lbs.	Hook style 4 ft add on single sided floor rack with Anodized Aluminum shelf tubes and painted steel frame with eight K73 powder coated steel triple prong hooks	Frame in Medium Gray, Sandstone or Black; Hooks in Charcoal Grey, Sandstone or Black; Shelf Tubes in Anodized Aluminum	672.00
	SKA5-AL	61"	60"	18 3/8"	45 lbs.	Hook style 5 ft single sided floor rack with Anodized Aluminum shelf tubes and painted steel frame with ten K73 powder coated steel triple prong hooks	Frame in Medium Gray, Sandstone or Black; Hooks in Charcoal Grey, Sandstone or Black; Shelf Tubes in Anodized Aluminum	887.00
	SKA5-AL-AO	61"	59"	18 3/8"	31 lbs.	Hook style 5 ft add on single sided floor rack with Anodized Aluminum shelf tubes and painted steel frame with ten K73 powder coated steel triple prong hooks	Frame in Medium Gray, Sandstone or Black; Hooks in Charcoal Grey, Sandstone or Black; Shelf Tubes in Anodized Aluminum	737.00

RIDGE DOUBLE HOOK FLOOR RACK (DKA)

FRAME FINISH COLORS



Medium Grey Black Sandstone

HOOK FINISH COLORS



Charcoal Grey Sandstone Black

SHELF TUBE FINISH COLORS



Medium Grey Black Sandstone Anodized Aluminum

HOW TO ORDER



Determine Freestanding Rack Width Select Shelf Tube Material/Color Select Frame & Hook Color

Example Order: DKA4-AL + 2x DKA4-AL-AO in Medium Grey with Black Hooks- 12' wide DKA Double Sided Freestanding Coat Rack in Medium Grey with Anodized Aluminum Shelf Tubes and Black Hooks (standard unit + 2 add-on units).

ADDITIONAL NOTES

ADD-ON MODELS

Customize your configuration by starting with a standard Ridge model & combining with add-on ("-AO") Ridge units to achieve desired width.



ADDITIONAL NOTES

Ships via Common Carrier.

Triple prong hooks secured to 2nd and 4th tubes from the front.











Longer lengths are available by combining basic and add-on units, which share a common upright. Per the product dimensions, add-on units are 1" narrower than standard units because they share an upright with adjacent standard units.

Caster base assembly can be added for mobility Model CBAXx. Includes set of four double wheel locking casters with spacer bar and shock bracing.

Sample chips available.

Submittal drawings are available upon request.



LINE ART	MODEL	H	W	D	WEIGHT	DESCRIPTION	COLOR/FINISH	LIST PRICE
	DKA3-ST	61"	36"	27 3/8"	36 lbs.	Hook style 3 ft double sided floor rack in powder coated steel with twelve K73 powder coated steel triple prong hooks	Frame & Shelves in Medium Grey, Sandstone or Black; Hooks in Charcoal Grey, Sandstone or Black	1,005.00
	DKA3-ST-AO	61"	35"	27 3/8"	23 lbs.	Hook style 3 ft add on double sided floor rack in powder coated steel with twelve K73 powder coated steel triple prong hooks	Frame & Shelves in Medium Grey, Sandstone or Black; Hooks in Charcoal Grey, Sandstone or Black	849.00
	DKA4-ST	61"	48"	27 3/8"	40 lbs.	Hook style 4 ft double sided floor rack in powder coated steel with sixteen K73 powder coated steel triple prong hooks	Frame & Shelves in Medium Grey, Sandstone or Black; Hooks in Charcoal Grey, Sandstone or Black	1,117.00
	DKA4-ST-AO	61"	47"	27 3/8"	26 lbs.	Hook style 4 ft add on double sided floor rack in powder coated steel with sixteen K73 powder coated steel triple prong hooks	Frame & Shelves in Medium Grey, Sandstone or Black; Hooks in Charcoal Grey, Sandstone or Black	952.00
	DKA5-ST	61"	60"	27 3/8"	45 lbs.	Hook style 5 ft double sided floor rack in powder coated steel with twenty four K73 powder coated steel triple prong hooks	Frame & Shelves in Medium Grey, Sandstone or Black; Hooks in Charcoal Grey, Sandstone or Black	1,226.00
	DKA5-ST-AO	61"	59"	27 3/8"	31 lbs.	Hook style 5 ft add on double sided floor rack in powder coated steel with twenty four K73 powder coated steel triple prong hooks	Frame & Shelves in Medium Grey, Sandstone or Black; Hooks in Charcoal Grey, Sandstone or Black	1,078.00
	DKA3-AL	61"	36"	27 3/8"	36 lbs.	Hook style 3 ft double sided floor rack with Anodized Aluminum shelf tubes and painted steel frame with twelve K73 powder coated steel triple prong hooks	Frame in Medium Gray, Sandstone or Black; Hooks in Charcoal Grey, Sandstone or Black; Shelf Tubes in Anodized Aluminum	1,158.00
	DKA3-AL-AO	61"	35"	27 3/8"	23 lbs.	Hook style 3 ft add on double sided floor rack with Anodized Aluminum shelf tubes and painted steel frame with twelve K73 powder coated steel triple prong hooks	Frame in Medium Gray, Sandstone or Black; Hooks in Charcoal Grey, Sandstone or Black; Shelf Tubes in Anodized Aluminum	964.00
	DKA4-AL	61"	48"	27 3/8"	40 lbs.	Hook style 4 ft double sided floor rack with Anodized Aluminum shelf tubes and painted steel frame with sixteen K73 powder coated steel triple prong hooks	Frame in Medium Gray, Sandstone or Black; Hooks in Charcoal Grey, Sandstone or Black; Shelf Tubes in Anodized Aluminum	1,287.00
	DKA4-AL-AO	61"	47"	27 3/8"	26 lbs.	Hook style 4 ft add on double sided floor rack with Anodized Aluminum shelf tubes and painted steel frame with sixteen K73 powder coated steel triple prong hooks	Frame in Medium Gray, Sandstone or Black; Hooks in Charcoal Grey, Sandstone or Black; Shelf Tubes in Anodized Aluminum	1,088.00
	DKA5-AL	61"	60"	27 3/8"	45 lbs.	Hook style 5 ft double sided floor rack with Anodized Aluminum shelf tubes and painted steel frame with twenty K73 powder coated steel triple prong hooks	Frame in Medium Gray, Sandstone or Black; Hooks in Charcoal Grey, Sandstone or Black; Shelf Tubes in Anodized Aluminum	1,402.00

	DKA5-AL-AO	61"	59"	27 3/8"	31 lbs.	Hook style 5 ft add on double sided floor rack with Anodized Aluminum shelf tubes and painted steel frame with twenty K73 powder coated steel triple prong hooks	Frame in Medium Gray, Sandstone or Black; Hooks in Charcoal Grey, Sandstone or Black; Shelf Tubes in Anodized Aluminum	1,234.00
	CBA-36D	Add 3" to height of rack	34"	N/A	9 lbs.	Set of four 2 1/2" double wheel locking casters with Spacer Bar and Shock Bracing. For use with DHA3 units.	Medium Grey, Sandstone or Black with Black Casters	175.00
	CBA-48D	Add 3" to height of rack	46"	N/A	10 lbs.	Set of four 2 1/2" double wheel locking casters with Spacer Bar and Shock Bracing. For use with DHA4 units.	Medium Grey, Sandstone or Black with Black Casters	186.00
	CBA-60D	Add 3" to height of rack	58"	N/A	11 lbs.	Set of four 2 1/2" double wheel locking casters with Spacer Bar and Shock Bracing. For use with DHA5 units.	Medium Grey, Sandstone or Black with Black Casters	204.00

VILLA HANGER WALL RACK (WH01A)

BRACKET FINISH COLORS



Medium Grey Black

Sandstone

Lunar White

Bronze
Metallic

SHELF TUBE FINISH COLORS



Medium Grey Black

Sandstone

Lunar White

Bronze
Metallic



Anodized
Aluminum



Natural Oak

HOW TO ORDER



Determine
Wall Rack
Width

Determine
Hook Rail
Width/Model

Select Shelf
Tube
Material/Color

Select
Bracket Color

Example Order: WH01A-AL-14 with Brackets in Black - 13' 4" wide WH01A Wall Rack with Black painted steel Brackets and Anodized Aluminum Shelves.

ADDITIONAL NOTES

CUSTOM WIDTH & PRICING

Villa Wall Racks are made to order with custom widths available to the nearest whole inch. Magnuson Group does not size to fractional inches (i.e. 12' 8 3/4" wide would be instead cut to 12' 8" wide).

When determining the model that corresponds to the custom width specified, round up to the nearest foot. For example, a 12' 3" wide WH01A unit would be priced using model WH01A-13 - this pricing would be the same for any WH01A unit with a width between 12' 1" and 13'.

MITRED CORNERS

For continuous shelving in L or U shaped wall configurations, Mitred Corners are available. Exact dimensions of each wall are required for pricing.

\$105.00 per corner per shelf.

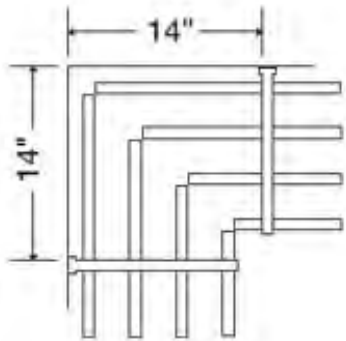

ADDITIONAL NOTES

Ships UPS where possible, otherwise Common Carrier is used.

Custom Villa WH01-A units accept standard 1-1/2" open hangers, CL closed loop hangers or R1.5 receptacles with MG17PP T-Top or MG17B ball top hangers.

Hangers not included. A maximum of 5 hangers per foot are recommended on all WH01-A wall racks.









For pricing on longer lengths, contact Customer Service.









Sample chips available.













Submittal drawings available upon request.













Hardware to secure the mounting brackets to the wall is not included due to the variety of possible surface applications.















LINE ART	MODEL	H	W	D	WEIGHT	DESCRIPTION	COLOR/FINISH	LIST PRICE
	WH01A-ST-2	13 1/2"	1 to 2 ft	11 1/2"	Approx 4 lbs per ft	Single shelf hanger style wall rack in powder coated steel finish with 1" o.d. stainless steel hanger rod and 2 brackets	Brackets in Medium Gray, Sandstone, Black, Lunar White or Bronze Metallic. Shelf Tubes in Medium Gray, Sandstone, Black, Lunar White or Bronze Metallic.	235.00
	WH01A-ST-3	13 1/2"	2 to 3 ft	11 1/2"	Approx 4 lbs per ft	Single shelf hanger style wall rack in powder coated steel finish with 1" o.d. stainless steel hanger rod and 2 brackets	Brackets in Medium Gray, Sandstone, Black, Lunar White or Bronze Metallic. Shelf Tubes in Medium Gray, Sandstone, Black, Lunar White or Bronze Metallic.	281.00
	WH01A-ST-4	13 1/2"	3 to 4 ft	11 1/2"	Approx 4 lbs per ft	Single shelf hanger style wall rack in powder coated steel finish with 1" o.d. stainless steel hanger rod and 2 brackets	Brackets in Medium Gray, Sandstone, Black, Lunar White or Bronze Metallic. Shelf Tubes in Medium Gray, Sandstone, Black, Lunar White or Bronze Metallic.	325.00
	WH01A-ST-5	13 1/2"	4 to 5 ft	11 1/2"	Approx 4 lbs per ft	Single shelf hanger style wall rack in powder coated steel finish with 1" o.d. stainless steel hanger rod and 3 brackets	Brackets in Medium Gray, Sandstone, Black, Lunar White or Bronze Metallic. Shelf Tubes in Medium Gray, Sandstone, Black, Lunar White or Bronze Metallic.	374.00
	WH01A-ST-6	13 1/2"	5 to 6 ft	11 1/2"	Approx 4 lbs per ft	Single shelf hanger style wall rack in powder coated steel finish with 1" o.d. stainless steel hanger rod and 3 brackets	Brackets in Medium Gray, Sandstone, Black, Lunar White or Bronze Metallic. Shelf Tubes in Medium Gray, Sandstone, Black, Lunar White or Bronze Metallic.	433.00
	WH01A-ST-7	13 1/2"	6 to 7 ft	11 1/2"	Approx 4 lbs per ft	Single shelf hanger style wall rack in powder coated steel finish with 1" o.d. stainless steel hanger rod and 3 brackets	Brackets in Medium Gray, Sandstone, Black, Lunar White or Bronze Metallic. Shelf Tubes in Medium Gray, Sandstone, Black, Lunar White or Bronze Metallic.	446.00
	WH01A-ST-8	13 1/2"	7 to 8 ft	11 1/2"	Approx 4 lbs per ft	Single shelf hanger style wall rack in powder coated steel finish with 1" o.d. stainless steel hanger rod and 4 brackets	Brackets in Medium Gray, Sandstone, Black, Lunar White or Bronze Metallic. Shelf Tubes in Medium Gray, Sandstone, Black, Lunar White or Bronze Metallic.	483.00
	WH01A-ST-9	13 1/2"	8 to 9 ft	11 1/2"	Approx 4 lbs per ft	Single shelf hanger style wall rack in powder coated steel finish with 1" o.d. stainless steel hanger rod and 4 brackets	Brackets in Medium Gray, Sandstone, Black, Lunar White or Bronze Metallic. Shelf Tubes in Medium Gray, Sandstone, Black, Lunar White or Bronze Metallic.	520.00
	WH01A-ST-10	13 1/2"	9 to 10 ft	11 1/2"	Approx 4 lbs per ft	Single shelf hanger style wall rack in powder coated steel finish with 1" o.d. stainless steel hanger rod and 4 brackets	Brackets in Medium Gray, Sandstone, Black, Lunar White or Bronze Metallic. Shelf Tubes in Medium Gray, Sandstone, Black, Lunar White or Bronze Metallic.	551.00

	WH01A-ST-11	13 1/2"	10 to 11 ft	11 1/2"	Approx 4 lbs per ft	Single shelf hanger style wall rack in powder coated steel finish with 1" o.d. stainless steel hanger rod and 5 brackets	Brackets in Medium Gray, Sandstone, Black, Lunar White or Bronze Metallic. Shelf Tubes in Medium Gray, Sandstone, Black, Lunar White or Bronze Metallic.	583.00
	WH01A-ST-12	13 1/2"	11 to 12 ft	11 1/2"	Approx 4 lbs per ft	Single shelf hanger style wall rack in powder coated steel finish with 1" o.d. stainless steel hanger rod and 5 brackets	Brackets in Medium Gray, Sandstone, Black, Lunar White or Bronze Metallic. Shelf Tubes in Medium Gray, Sandstone, Black, Lunar White or Bronze Metallic.	627.00
	WH01A-ST-13	13 1/2"	12 to 13 ft	11 1/2"	Approx 4 lbs per ft	Single shelf hanger style wall rack in powder coated steel finish with 1" o.d. stainless steel hanger rod and 5 brackets	Brackets in Medium Gray, Sandstone, Black, Lunar White or Bronze Metallic. Shelf Tubes in Medium Gray, Sandstone, Black, Lunar White or Bronze Metallic.	659.00
	WH01A-ST-14	13 1/2"	13 to 14 ft	11 1/2"	Approx 4 lbs per ft	Single shelf hanger style wall rack in powder coated steel finish with 1" o.d. stainless steel hanger rod and 6 brackets	Brackets in Medium Gray, Sandstone, Black, Lunar White or Bronze Metallic. Shelf Tubes in Medium Gray, Sandstone, Black, Lunar White or Bronze Metallic.	697.00
	WH01A-ST-15	13 1/2"	14 to 15 ft	11 1/2"	Approx 4 lbs per ft	Single shelf hanger style wall rack in powder coated steel finish with 1" o.d. stainless steel hanger rod and 6 brackets	Brackets in Medium Gray, Sandstone, Black, Lunar White or Bronze Metallic. Shelf Tubes in Medium Gray, Sandstone, Black, Lunar White or Bronze Metallic.	744.00
	WH01A-ST-16	13 1/2"	15 to 16 ft	11 1/2"	Approx 4 lbs per ft	Single shelf hanger style wall rack in powder coated steel finish with 1" o.d. stainless steel hanger rod and 6 brackets	Brackets in Medium Gray, Sandstone, Black, Lunar White or Bronze Metallic. Shelf Tubes in Medium Gray, Sandstone, Black, Lunar White or Bronze Metallic.	783.00
	WH01A-ST-17	13 1/2"	16 to 17 ft	11 1/2"	Approx 4 lbs per ft	Single shelf hanger style wall rack in powder coated steel finish with 1" o.d. stainless steel hanger rod and 7 brackets	Brackets in Medium Gray, Sandstone, Black, Lunar White or Bronze Metallic. Shelf Tubes in Medium Gray, Sandstone, Black, Lunar White or Bronze Metallic.	836.00
	WH01A-ST-18	13 1/2"	17 to 18 ft	11 1/2"	Approx 4 lbs per ft	Single shelf hanger style wall rack in powder coated steel finish with 1" o.d. stainless steel hanger rod and 7 brackets	Brackets in Medium Gray, Sandstone, Black, Lunar White or Bronze Metallic. Shelf Tubes in Medium Gray, Sandstone, Black, Lunar White or Bronze Metallic.	890.00
	WH01A-ST-19	13 1/2"	18 to 19 ft	11 1/2"	Approx 4 lbs per ft	Single shelf hanger style wall rack in powder coated steel finish with 1" o.d. stainless steel hanger rod and 7 brackets	Brackets in Medium Gray, Sandstone, Black, Lunar White or Bronze Metallic. Shelf Tubes in Medium Gray, Sandstone, Black, Lunar White or Bronze Metallic.	944.00

	WH01A-ST-20	13 1/2"	19 to 20 ft	11 1/2"	Approx 4 lbs per ft	Single shelf hanger style wall rack in powder coated steel finish with 1" o.d. stainless steel hanger rod and 7 brackets	Brackets in Medium Gray, Sandstone, Black, Lunar White or Bronze Metallic. Shelf Tubes in Medium Gray, Sandstone, Black, Lunar White or Bronze Metallic.	998.00
	WH01A-AL-2	13 1/2"	1 to 2 ft	11 1/2"	Approx 4 lbs per ft	Single shelf hanger style wall rack with silver anodized aluminum shelf tubes, powder coated steel brackets and 1" o.d. stainless steel hanger rod and 2 brackets	Brackets in Medium Gray, Sandstone, Black, Lunar White or Bronze Metallic. Shelf Tubes in Anodized Aluminum.	252.00
	WH01A-AL-3	13 1/2"	2 to 3 ft	11 1/2"	Approx 4 lbs per ft	Single shelf hanger style wall rack with silver anodized aluminum shelf tubes, powder coated steel brackets and 1" o.d. stainless steel hanger rod and 2 brackets	Brackets in Medium Gray, Sandstone, Black, Lunar White or Bronze Metallic. Shelf Tubes in Anodized Aluminum.	292.00
	WH01A-AL-4	13 1/2"	3 to 4 ft	11 1/2"	Approx 4 lbs per ft	Single shelf hanger style wall rack with silver anodized aluminum shelf tubes, powder coated steel brackets and 1" o.d. stainless steel hanger rod and 2 brackets	Brackets in Medium Gray, Sandstone, Black, Lunar White or Bronze Metallic. Shelf Tubes in Anodized Aluminum.	329.00
	WH01A-AL-5	13 1/2"	4 to 5 ft	11 1/2"	Approx 4 lbs per ft	Single shelf hanger style wall rack with silver anodized aluminum shelf tubes, powder coated steel brackets and 1" o.d. stainless steel hanger rod and 3 brackets	Brackets in Medium Gray, Sandstone, Black, Lunar White or Bronze Metallic. Shelf Tubes in Anodized Aluminum.	423.00
	WH01A-AL-6	13 1/2"	5 to 6 ft	11 1/2"	Approx 4 lbs per ft	Single shelf hanger style wall rack with silver anodized aluminum shelf tubes, powder coated steel brackets and 1" o.d. stainless steel hanger rod and 3 brackets	Brackets in Medium Gray, Sandstone, Black, Lunar White or Bronze Metallic. Shelf Tubes in Anodized Aluminum.	474.00
	WH01A-AL-7	13 1/2"	6 to 7 ft	11 1/2"	Approx 4 lbs per ft	Single shelf hanger style wall rack with silver anodized aluminum shelf tubes, powder coated steel brackets and 1" o.d. stainless steel hanger rod and 3 brackets	Brackets in Medium Gray, Sandstone, Black, Lunar White or Bronze Metallic. Shelf Tubes in Anodized Aluminum.	496.00
	WH01A-AL-8	13 1/2"	7 to 8 ft	11 1/2"	Approx 4 lbs per ft	Single shelf hanger style wall rack with silver anodized aluminum shelf tubes, powder coated steel brackets and 1" o.d. stainless steel hanger rod and 4 brackets	Brackets in Medium Gray, Sandstone, Black, Lunar White or Bronze Metallic. Shelf Tubes in Anodized Aluminum.	528.00
	WH01A-AL-9	13 1/2"	8 to 9 ft	11 1/2"	Approx 4 lbs per ft	Single shelf hanger style wall rack with silver anodized aluminum shelf tubes, powder coated steel brackets and 1" o.d. stainless steel hanger rod and 4 brackets	Brackets in Medium Gray, Sandstone, Black, Lunar White or Bronze Metallic. Shelf Tubes in Anodized Aluminum.	556.00
	WH01A-AL-10	13 1/2"	9 to 10 ft	11 1/2"	Approx 4 lbs per ft	Single shelf hanger style wall rack with silver anodized aluminum shelf tubes, powder coated steel brackets and 1" o.d. stainless steel hanger rod and 4 brackets	Brackets in Medium Gray, Sandstone, Black, Lunar White or Bronze Metallic. Shelf Tubes in Anodized Aluminum.	612.00
	WH01A-AL-11	13 1/2"	10 to 11 ft	11 1/2"	Approx 4 lbs per ft	Single shelf hanger style wall rack with silver anodized aluminum shelf tubes, powder coated steel brackets and 1" o.d. stainless steel hanger rod and 5 brackets	Brackets in Medium Gray, Sandstone, Black, Lunar White or Bronze Metallic. Shelf Tubes in Anodized Aluminum.	686.00
	WH01A-AL-12	13 1/2"	11 to 12 ft	11 1/2"	Approx 4 lbs per ft	Single shelf hanger style wall rack with silver anodized aluminum shelf tubes, powder coated steel brackets and 1" o.d. stainless steel hanger rod and 5 brackets	Brackets in Medium Gray, Sandstone, Black, Lunar White or Bronze Metallic. Shelf Tubes in Anodized Aluminum.	719.00

	WH01A-AL-13	13 1/2"	12 to 13 ft	11 1/2"	Approx 4 lbs per ft	Single shelf hanger style wall rack with silver anodized aluminum shelf tubes, powder coated steel brackets and 1" o.d. stainless steel hanger rod and 5 brackets	Brackets in Medium Gray, Sandstone, Black, Lunar White or Bronze Metallic. Shelf Tubes in Anodized Aluminum.	755.00
	WH01A-AL-14	13 1/2"	13 to 14 ft	11 1/2"	Approx 4 lbs per ft	Single shelf hanger style wall rack with silver anodized aluminum shelf tubes, powder coated steel brackets and 1" o.d. stainless steel hanger rod and 6 brackets	Brackets in Medium Gray, Sandstone, Black, Lunar White or Bronze Metallic. Shelf Tubes in Anodized Aluminum.	783.00
	WH01A-AL-15	13 1/2"	14 to 15 ft	11 1/2"	Approx 4 lbs per ft	Single shelf hanger style wall rack with silver anodized aluminum shelf tubes, powder coated steel brackets and 1" o.d. stainless steel hanger rod and 6 brackets	Brackets in Medium Gray, Sandstone, Black, Lunar White or Bronze Metallic. Shelf Tubes in Anodized Aluminum.	847.00
	WH01A-AL-16	13 1/2"	15 to 16 ft	11 1/2"	Approx 4 lbs per ft	Single shelf hanger style wall rack with silver anodized aluminum shelf tubes, powder coated steel brackets and 1" o.d. stainless steel hanger rod and 6 brackets	Brackets in Medium Gray, Sandstone, Black, Lunar White or Bronze Metallic. Shelf Tubes in Anodized Aluminum.	878.00
	WH01A-AL-17	13 1/2"	16 to 17 ft	11 1/2"	Approx 4 lbs per ft	Single shelf hanger style wall rack with silver anodized aluminum shelf tubes, powder coated steel brackets and 1" o.d. stainless steel hanger rod and 7 brackets	Brackets in Medium Gray, Sandstone, Black, Lunar White or Bronze Metallic. Shelf Tubes in Anodized Aluminum.	944.00
	WH01A-AL-18	13 1/2"	17 to 18 ft	11 1/2"	Approx 4 lbs per ft	Single shelf hanger style wall rack with silver anodized aluminum shelf tubes, powder coated steel brackets and 1" o.d. stainless steel hanger rod and 7 brackets	Brackets in Medium Gray, Sandstone, Black, Lunar White or Bronze Metallic. Shelf Tubes in Anodized Aluminum.	1,005.00
	WH01A-AL-19	13 1/2"	18 to 19 ft	11 1/2"	Approx 4 lbs per ft	Single shelf hanger style wall rack with silver anodized aluminum shelf tubes, powder coated steel brackets and 1" o.d. stainless steel hanger rod and 7 brackets	Brackets in Medium Gray, Sandstone, Black, Lunar White or Bronze Metallic. Shelf Tubes in Anodized Aluminum.	1,058.00
	WH01A-AL-20	13 1/2"	19 to 20 ft	11 1/2"	Approx 4 lbs per ft	Single shelf hanger style wall rack with silver anodized aluminum shelf tubes, powder coated steel brackets and 1" o.d. stainless steel hanger rod and 7 brackets	Brackets in Medium Gray, Sandstone, Black, Lunar White or Bronze Metallic. Shelf Tubes in Anodized Aluminum.	1,130.00
	WH01A-OK-2	13 1/2"	1 to 2 ft	11 1/2"	Approx 4 lbs per ft	Single shelf hanger style wall rack with 3/4" square oak shelf bars, powder coated steel brackets and 1" o.d. stainless steel hanger rod and 2 brackets	Brackets in Medium Gray, Sandstone, Black, Lunar White or Bronze Metallic. Shelf Tubes in Natural Oak.	254.00
	WH01A-OK-3	13 1/2"	2 to 3 ft	11 1/2"	Approx 4 lbs per ft	Single shelf hanger style wall rack with 3/4" square oak shelf bars, powder coated steel brackets and 1" o.d. stainless steel hanger rod and 2 brackets	Brackets in Medium Gray, Sandstone, Black, Lunar White or Bronze Metallic. Shelf Tubes in Natural Oak.	349.00
	WH01A-OK-4	13 1/2"	3 to 4 ft	11 1/2"	Approx 4 lbs per ft	Single shelf hanger style wall rack with 3/4" square oak shelf bars, powder coated steel brackets and 1" o.d. stainless steel hanger rod and 2 brackets	Brackets in Medium Gray, Sandstone, Black, Lunar White or Bronze Metallic. Shelf Tubes in Natural Oak.	389.00
	WH01A-OK-5	13 1/2"	4 to 5 ft	11 1/2"	Approx 4 lbs per ft	Single shelf hanger style wall rack with 3/4" square oak shelf bars, powder coated steel brackets and 1" o.d. stainless steel hanger rod and 3 brackets	Brackets in Medium Gray, Sandstone, Black, Lunar White or Bronze Metallic. Shelf Tubes in Natural Oak.	520.00
	WH01A-OK-6	13 1/2"	5 to 6 ft	11 1/2"	Approx 4 lbs per ft	Single shelf hanger style wall rack with 3/4" square oak shelf bars, powder coated steel brackets and 1" o.d. stainless steel hanger rod and 3 brackets	Brackets in Medium Gray, Sandstone, Black, Lunar White or Bronze Metallic. Shelf Tubes in Natural Oak.	555.00

	WH01A-OK-7	13 1/2"	6 to 7 ft	11 1/2"	Approx 4 lbs per ft	Single shelf hanger style wall rack with 3/4" square oak shelf bars, powder coated steel brackets and 1" o.d. stainless steel hanger rod and 3 brackets	Brackets in Medium Gray, Sandstone, Black, Lunar White or Bronze Metallic. Shelf Tubes in Natural Oak.	572.00
	WH01A-OK-8	13 1/2"	7 to 8 ft	11 1/2"	Approx 4 lbs per ft	Single shelf hanger style wall rack with 3/4" square oak shelf bars, powder coated steel brackets and 1" o.d. stainless steel hanger rod and 4 brackets	Brackets in Medium Gray, Sandstone, Black, Lunar White or Bronze Metallic. Shelf Tubes in Natural Oak.	648.00
	WH01A-OK-9	13 1/2"	8 to 9 ft	11 1/2"	Approx 4 lbs per ft	Single shelf hanger style wall rack with 3/4" square oak shelf bars, powder coated steel brackets and 1" o.d. stainless steel hanger rod and 4 brackets	Brackets in Medium Gray, Sandstone, Black, Lunar White or Bronze Metallic. Shelf Tubes in Natural Oak.	697.00
	WH01A-OK-10	13 1/2"	9 to 10 ft	11 1/2"	Approx 4 lbs per ft	Single shelf hanger style wall rack with 3/4" square oak shelf bars, powder coated steel brackets and 1" o.d. stainless steel hanger rod and 4 brackets	Brackets in Medium Gray, Sandstone, Black, Lunar White or Bronze Metallic. Shelf Tubes in Natural Oak.	802.00
	WH01A-OK-11	13 1/2"	10 to 11 ft	11 1/2"	Approx 4 lbs per ft	Single shelf hanger style wall rack with 3/4" square oak shelf bars, powder coated steel brackets and 1" o.d. stainless steel hanger rod and 5 brackets	Brackets in Medium Gray, Sandstone, Black, Lunar White or Bronze Metallic. Shelf Tubes in Natural Oak.	907.00
	WH01A-OK-12	13 1/2"	11 to 12 ft	11 1/2"	Approx 4 lbs per ft	Single shelf hanger style wall rack with 3/4" square oak shelf bars, powder coated steel brackets and 1" o.d. stainless steel hanger rod and 5 brackets	Brackets in Medium Gray, Sandstone, Black, Lunar White or Bronze Metallic. Shelf Tubes in Natural Oak.	951.00
	WH01A-OK-13	13 1/2"	12 to 13 ft	11 1/2"	Approx 4 lbs per ft	Single shelf hanger style wall rack with 3/4" square oak shelf bars, powder coated steel brackets and 1" o.d. stainless steel hanger rod and 5 brackets	Brackets in Medium Gray, Sandstone, Black, Lunar White or Bronze Metallic. Shelf Tubes in Natural Oak.	1,032.00
	WH01A-OK-14	13 1/2"	13 to 14 ft	11 1/2"	Approx 4 lbs per ft	Single shelf hanger style wall rack with 3/4" square oak shelf bars, powder coated steel brackets and 1" o.d. stainless steel hanger rod and 6 brackets	Brackets in Medium Gray, Sandstone, Black, Lunar White or Bronze Metallic. Shelf Tubes in Natural Oak.	1,107.00
	WH01A-OK-15	13 1/2"	14 to 15 ft	11 1/2"	Approx 4 lbs per ft	Single shelf hanger style wall rack with 3/4" square oak shelf bars, powder coated steel brackets and 1" o.d. stainless steel hanger rod and 6 brackets	Brackets in Medium Gray, Sandstone, Black, Lunar White or Bronze Metallic. Shelf Tubes in Natural Oak.	1,183.00
	WH01A-OK-16	13 1/2"	15 to 16 ft	11 1/2"	Approx 4 lbs per ft	Single shelf hanger style wall rack with 3/4" square oak shelf bars, powder coated steel brackets and 1" o.d. stainless steel hanger rod and 6 brackets	Brackets in Medium Gray, Sandstone, Black, Lunar White or Bronze Metallic. Shelf Tubes in Natural Oak.	1,301.00
	WH01A-OK-17	13 1/2"	16 to 17 ft	11 1/2"	Approx 4 lbs per ft	Single shelf hanger style wall rack with 3/4" square oak shelf bars, powder coated steel brackets and 1" o.d. stainless steel hanger rod and 7 brackets	Brackets in Medium Gray, Sandstone, Black, Lunar White or Bronze Metallic. Shelf Tubes in Natural Oak.	1,377.00
	WH01A-OK-18	13 1/2"	17 to 18 ft	11 1/2"	Approx 4 lbs per ft	Single shelf hanger style wall rack with 3/4" square oak shelf bars, powder coated steel brackets and 1" o.d. stainless steel hanger rod and 7 brackets	Brackets in Medium Gray, Sandstone, Black, Lunar White or Bronze Metallic. Shelf Tubes in Natural Oak.	1,449.00
	WH01A-OK-19	13 1/2"	18 to 19 ft	11 1/2"	Approx 4 lbs per ft	Single shelf hanger style wall rack with 3/4" square oak shelf bars, powder coated steel brackets and 1" o.d. stainless steel hanger rod and 7 brackets	Brackets in Medium Gray, Sandstone, Black, Lunar White or Bronze Metallic. Shelf Tubes in Natural Oak.	1,520.00



WH01A-OK-20

13 1/2"

19 to 20 ft

11 1/2"

Approx 4
lbs per ft

Single shelf hanger style wall rack with 3/4" square oak shelf bars, powder coated steel brackets and 1" o.d. stainless steel hanger rod and 7 brackets

Brackets in Medium Gray, Sandstone, Black, Lunar White or Bronze Metallic. Shelf Tubes in Natural Oak.

1,591.00

VILLA DOUBLE HANGER WALL RACK (WH02A)

BRACKET FINISH COLORS



Medium Grey Black

Sandstone

Lunar White

Bronze
Metallic

SHELF TUBE FINISH COLORS



Medium Grey Black

Sandstone

Lunar White

Bronze
Metallic



Anodized
Aluminum



Natural Oak

HOW TO ORDER



Determine Hook Rail Width/Model
Select Shelf Tube Material/Color
Select Bracket Color

Example Order: WH02A-ST-8 in Medium Grey - 7' 10" wide WH02A Double Shelf Wall Rack in Medium Grey.

ADDITIONAL NOTES

CUSTOM WIDTH & PRICING

Villa Wall Racks are made to order with custom widths available to the nearest whole inch. Magnuson Group does not size to fractional inches (i.e. 12' 8 3/4" wide would be instead cut to 12' 8" wide).

When determining the model that corresponds to the custom width specified, round up to the nearest foot. For example, a 12' 3" wide WH02A unit would be priced using model WH02A-13 - this pricing would be the same for any WH02A unit with a width between 12' 1" and 13'.

MITRED CORNERS

For continuous shelving in L or U shaped wall configurations, Mitred Corners are available. Exact dimensions of each wall are required for pricing.

\$105.00 per corner per shelf.

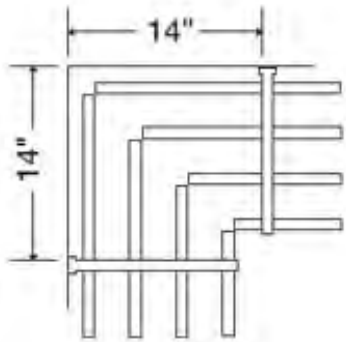

ADDITIONAL NOTES

Ships UPS where possible, otherwise Common Carrier is used.

Custom Villa WH02-A units accept standard 1-1/2" open hangers, CL closed loop hangers or R1.5 receptacles with MG17PP T-Top or MG17B ball top hangers.

Hangers not included. A maximum of 5 hangers per foot are recommended on all WH02-A wall racks.









For pricing on longer lengths, contact Customer Service.









Sample chips available.













Submittal drawings available upon request.













Hardware to secure the mounting brackets to the wall is not included due to the variety of possible surface applications.















LINE ART	MODEL	H	W	D	WEIGHT	DESCRIPTION	COLOR/FINISH	LIST PRICE
	WHO2A-ST-2	19 3/4"	1 to 2 ft	11 1/2"	Approx 7 lbs per ft	Double shelf hanger style wall rack in powder coated steel finish with 1" o.d. stainless steel hanger rod on lower shelf and 2 brackets	Brackets in Medium Gray, Sandstone, Black, Lunar White or Bronze Metallic. Shelf Tubes in Medium Gray, Sandstone, Black, Lunar White or Bronze Metallic.	357.00
	WHO2A-ST-3	19 3/4"	2 to 3 ft	11 1/2"	Approx 7 lbs per ft	Double shelf hanger style wall rack in powder coated steel finish with 1" o.d. stainless steel hanger rod on lower shelf and 2 brackets	Brackets in Medium Gray, Sandstone, Black, Lunar White or Bronze Metallic. Shelf Tubes in Medium Gray, Sandstone, Black, Lunar White or Bronze Metallic.	394.00
	WHO2A-ST-4	19 3/4"	3 to 4 ft	11 1/2"	Approx 7 lbs per ft	Double shelf hanger style wall rack in powder coated steel finish with 1" o.d. stainless steel hanger rod on lower shelf and 2 brackets	Brackets in Medium Gray, Sandstone, Black, Lunar White or Bronze Metallic. Shelf Tubes in Medium Gray, Sandstone, Black, Lunar White or Bronze Metallic.	470.00
	WHO2A-ST-5	19 3/4"	4 to 5 ft	11 1/2"	Approx 7 lbs per ft	Double shelf hanger style wall rack in powder coated steel finish with 1" o.d. stainless steel hanger rod on lower shelf and 3 brackets	Brackets in Medium Gray, Sandstone, Black, Lunar White or Bronze Metallic. Shelf Tubes in Medium Gray, Sandstone, Black, Lunar White or Bronze Metallic.	596.00
	WHO2A-ST-6	19 3/4"	5 to 6 ft	11 1/2"	Approx 7 lbs per ft	Double shelf hanger style wall rack in powder coated steel finish with 1" o.d. stainless steel hanger rod on lower shelf and 3 brackets	Brackets in Medium Gray, Sandstone, Black, Lunar White or Bronze Metallic. Shelf Tubes in Medium Gray, Sandstone, Black, Lunar White or Bronze Metallic.	628.00
	WHO2A-ST-7	19 3/4"	6 to 7 ft	11 1/2"	Approx 7 lbs per ft	Double shelf hanger style wall rack in powder coated steel finish with 1" o.d. stainless steel hanger rod on lower shelf and 3 brackets	Brackets in Medium Gray, Sandstone, Black, Lunar White or Bronze Metallic. Shelf Tubes in Medium Gray, Sandstone, Black, Lunar White or Bronze Metallic.	716.00
	WHO2A-ST-8	19 3/4"	7 to 8 ft	11 1/2"	Approx 7 lbs per ft	Double shelf hanger style wall rack in powder coated steel finish with 1" o.d. stainless steel hanger rod on lower shelf and 4 brackets	Brackets in Medium Gray, Sandstone, Black, Lunar White or Bronze Metallic. Shelf Tubes in Medium Gray, Sandstone, Black, Lunar White or Bronze Metallic.	818.00
	WHO2A-ST-9	19 3/4"	8 to 9 ft	11 1/2"	Approx 7 lbs per ft	Double shelf hanger style wall rack in powder coated steel finish with 1" o.d. stainless steel hanger rod on lower shelf and 4 brackets	Brackets in Medium Gray, Sandstone, Black, Lunar White or Bronze Metallic. Shelf Tubes in Medium Gray, Sandstone, Black, Lunar White or Bronze Metallic.	858.00
	WHO2A-ST-10	19 3/4"	9 to 10 ft	11 1/2"	Approx 7 lbs per ft	Double shelf hanger style wall rack in powder coated steel finish with 1" o.d. stainless steel hanger rod on lower shelf and 4 brackets	Brackets in Medium Gray, Sandstone, Black, Lunar White or Bronze Metallic. Shelf Tubes in Medium Gray, Sandstone, Black, Lunar White or Bronze Metallic.	918.00

	WHO2A-ST-11	19 3/4"	10 to 11 ft	11 1/2"	Approx 7 lbs per ft	Double shelf hanger style wall rack in powder coated steel finish with 1" o.d. stainless steel hanger rod on lower shelf and 5 brackets	Brackets in Medium Gray, Sandstone, Black, Lunar White or Bronze Metallic. Shelf Tubes in Medium Gray, Sandstone, Black, Lunar White or Bronze Metallic.	1,058.00
	WHO2A-ST-12	19 3/4"	11 to 12 ft	11 1/2"	Approx 7 lbs per ft	Double shelf hanger style wall rack in powder coated steel finish with 1" o.d. stainless steel hanger rod on lower shelf and 5 brackets	Brackets in Medium Gray, Sandstone, Black, Lunar White or Bronze Metallic. Shelf Tubes in Medium Gray, Sandstone, Black, Lunar White or Bronze Metallic.	1,105.00
	WHO2A-ST-13	19 3/4"	12 to 13 ft	11 1/2"	Approx 7 lbs per ft	Double shelf hanger style wall rack in powder coated steel finish with 1" o.d. stainless steel hanger rod on lower shelf and 5 brackets	Brackets in Medium Gray, Sandstone, Black, Lunar White or Bronze Metallic. Shelf Tubes in Medium Gray, Sandstone, Black, Lunar White or Bronze Metallic.	1,166.00
	WHO2A-ST-14	19 3/4"	13 to 14 ft	11 1/2"	Approx 7 lbs per ft	Double shelf hanger style wall rack in powder coated steel finish with 1" o.d. stainless steel hanger rod on lower shelf and 6 brackets	Brackets in Medium Gray, Sandstone, Black, Lunar White or Bronze Metallic. Shelf Tubes in Medium Gray, Sandstone, Black, Lunar White or Bronze Metallic.	1,221.00
	WHO2A-ST-15	19 3/4"	14 to 15 ft	11 1/2"	Approx 7 lbs per ft	Double shelf hanger style wall rack in powder coated steel finish with 1" o.d. stainless steel hanger rod on lower shelf and 6 brackets	Brackets in Medium Gray, Sandstone, Black, Lunar White or Bronze Metallic. Shelf Tubes in Medium Gray, Sandstone, Black, Lunar White or Bronze Metallic.	1,356.00
	WHO2A-ST-16	19 3/4"	15 to 16 ft	11 1/2"	Approx 7 lbs per ft	Double shelf hanger style wall rack in powder coated steel finish with 1" o.d. stainless steel hanger rod on lower shelf and 6 brackets	Brackets in Medium Gray, Sandstone, Black, Lunar White or Bronze Metallic. Shelf Tubes in Medium Gray, Sandstone, Black, Lunar White or Bronze Metallic.	1,415.00
	WHO2A-ST-17	19 3/4"	16 to 17 ft	11 1/2"	Approx 7 lbs per ft	Double shelf hanger style wall rack in powder coated steel finish with 1" o.d. stainless steel hanger rod on lower shelf and 7 brackets	Brackets in Medium Gray, Sandstone, Black, Lunar White or Bronze Metallic. Shelf Tubes in Medium Gray, Sandstone, Black, Lunar White or Bronze Metallic.	1,514.00
	WHO2A-ST-18	19 3/4"	17 to 18 ft	11 1/2"	Approx 7 lbs per ft	Double shelf hanger style wall rack in powder coated steel finish with 1" o.d. stainless steel hanger rod on lower shelf and 7 brackets	Brackets in Medium Gray, Sandstone, Black, Lunar White or Bronze Metallic. Shelf Tubes in Medium Gray, Sandstone, Black, Lunar White or Bronze Metallic.	1,616.00
	WHO2A-ST-19	19 3/4"	18 to 19 ft	11 1/2"	Approx 7 lbs per ft	Double shelf hanger style wall rack in powder coated steel finish with 1" o.d. stainless steel hanger rod on lower shelf and 7 brackets	Brackets in Medium Gray, Sandstone, Black, Lunar White or Bronze Metallic. Shelf Tubes in Medium Gray, Sandstone, Black, Lunar White or Bronze Metallic.	1,715.00

	WHO2A-ST-20	19 3/4"	19 to 20 ft	11 1/2"	Approx 7 lbs per ft	Double shelf hanger style wall rack in powder coated steel finish with 1" o.d. stainless steel hanger rod on lower shelf and 7 brackets	Brackets in Medium Gray, Sandstone, Black, Lunar White or Bronze Metallic. Shelf Tubes in Medium Gray, Sandstone, Black, Lunar White or Bronze Metallic.	1,816.00
	WHO2A-AL-2	19 3/4"	1 to 2 ft	11 1/2"	Approx 7 lbs per ft	Double shelf hanger style wall rack with silver anodized aluminum shelf tubes, powder coated steel brackets and 1" o.d. stainless steel hanger rod on lower shelf and 2 brackets	Brackets in Medium Gray, Sandstone, Black, Lunar White or Bronze Metallic. Shelf Tubes in Anodized Aluminum.	393.00
	WHO2A-AL-3	19 3/4"	2 to 3 ft	11 1/2"	Approx 7 lbs per ft	Double shelf hanger style wall rack with silver anodized aluminum shelf tubes, powder coated steel brackets and 1" o.d. stainless steel hanger rod on lower shelf and 2 brackets	Brackets in Medium Gray, Sandstone, Black, Lunar White or Bronze Metallic. Shelf Tubes in Anodized Aluminum.	464.00
	WHO2A-AL-4	19 3/4"	3 to 4 ft	11 1/2"	Approx 7 lbs per ft	Double shelf hanger style wall rack with silver anodized aluminum shelf tubes, powder coated steel brackets and 1" o.d. stainless steel hanger rod on lower shelf and 2 brackets	Brackets in Medium Gray, Sandstone, Black, Lunar White or Bronze Metallic. Shelf Tubes in Anodized Aluminum.	528.00
	WHO2A-AL-5	19 3/4"	4 to 5 ft	11 1/2"	Approx 7 lbs per ft	Double shelf hanger style wall rack with silver anodized aluminum shelf tubes, powder coated steel brackets and 1" o.d. stainless steel hanger rod on lower shelf and 3 brackets	Brackets in Medium Gray, Sandstone, Black, Lunar White or Bronze Metallic. Shelf Tubes in Anodized Aluminum.	675.00
	WHO2A-AL-6	19 3/4"	5 to 6 ft	11 1/2"	Approx 7 lbs per ft	Double shelf hanger style wall rack with silver anodized aluminum shelf tubes, powder coated steel brackets and 1" o.d. stainless steel hanger rod on lower shelf and 3 brackets	Brackets in Medium Gray, Sandstone, Black, Lunar White or Bronze Metallic. Shelf Tubes in Anodized Aluminum.	712.00
	WHO2A-AL-7	19 3/4"	6 to 7 ft	11 1/2"	Approx 7 lbs per ft	Double shelf hanger style wall rack with silver anodized aluminum shelf tubes, powder coated steel brackets and 1" o.d. stainless steel hanger rod on lower shelf and 3 brackets	Brackets in Medium Gray, Sandstone, Black, Lunar White or Bronze Metallic. Shelf Tubes in Anodized Aluminum.	811.00
	WHO2A-AL-8	19 3/4"	7 to 8 ft	11 1/2"	Approx 7 lbs per ft	Double shelf hanger style wall rack with silver anodized aluminum shelf tubes, powder coated steel brackets and 1" o.d. stainless steel hanger rod on lower shelf and 4 brackets	Brackets in Medium Gray, Sandstone, Black, Lunar White or Bronze Metallic. Shelf Tubes in Anodized Aluminum.	907.00
	WHO2A-AL-9	19 3/4"	8 to 9 ft	11 1/2"	Approx 7 lbs per ft	Double shelf hanger style wall rack with silver anodized aluminum shelf tubes, powder coated steel brackets and 1" o.d. stainless steel hanger rod on lower shelf and 4 brackets	Brackets in Medium Gray, Sandstone, Black, Lunar White or Bronze Metallic. Shelf Tubes in Anodized Aluminum.	966.00
	WHO2A-AL-10	19 3/4"	9 to 10 ft	11 1/2"	Approx 7 lbs per ft	Double shelf hanger style wall rack with silver anodized aluminum shelf tubes, powder coated steel brackets and 1" o.d. stainless steel hanger rod on lower shelf and 4 brackets	Brackets in Medium Gray, Sandstone, Black, Lunar White or Bronze Metallic. Shelf Tubes in Anodized Aluminum.	1,058.00
	WHO2A-AL-11	19 3/4"	10 to 11 ft	11 1/2"	Approx 7 lbs per ft	Double shelf hanger style wall rack with silver anodized aluminum shelf tubes, powder coated steel brackets and 1" o.d. stainless steel hanger rod on lower shelf and 5 brackets	Brackets in Medium Gray, Sandstone, Black, Lunar White or Bronze Metallic. Shelf Tubes in Anodized Aluminum.	1,212.00
	WHO2A-AL-12	19 3/4"	11 to 12 ft	11 1/2"	Approx 7 lbs per ft	Double shelf hanger style wall rack with silver anodized aluminum shelf tubes, powder coated steel brackets and 1" o.d. stainless steel hanger rod on lower shelf and 5 brackets	Brackets in Medium Gray, Sandstone, Black, Lunar White or Bronze Metallic. Shelf Tubes in Anodized Aluminum.	1,262.00

	WHO2A-AL-13	19 3/4"	12 to 13 ft	11 1/2"	Approx 7 lbs per ft	Double shelf hanger style wall rack with silver anodized aluminum shelf tubes, powder coated steel brackets and 1" o.d. stainless steel hanger rod on lower shelf and 5 brackets	Brackets in Medium Gray, Sandstone, Black, Lunar White or Bronze Metallic. Shelf Tubes in Anodized Aluminum.	1,340.00
	WHO2A-AL-14	19 3/4"	13 to 14 ft	11 1/2"	Approx 7 lbs per ft	Double shelf hanger style wall rack with silver anodized aluminum shelf tubes, powder coated steel brackets and 1" o.d. stainless steel hanger rod on lower shelf and 6 brackets	Brackets in Medium Gray, Sandstone, Black, Lunar White or Bronze Metallic. Shelf Tubes in Anodized Aluminum.	1,418.00
	WHO2A-AL-15	19 3/4"	14 to 15 ft	11 1/2"	Approx 7 lbs per ft	Double shelf hanger style wall rack with silver anodized aluminum shelf tubes, powder coated steel brackets and 1" o.d. stainless steel hanger rod on lower shelf and 6 brackets	Brackets in Medium Gray, Sandstone, Black, Lunar White or Bronze Metallic. Shelf Tubes in Anodized Aluminum.	1,573.00
	WHO2A-AL-16	19 3/4"	15 to 16 ft	11 1/2"	Approx 7 lbs per ft	Double shelf hanger style wall rack with silver anodized aluminum shelf tubes, powder coated steel brackets and 1" o.d. stainless steel hanger rod on lower shelf and 6 brackets	Brackets in Medium Gray, Sandstone, Black, Lunar White or Bronze Metallic. Shelf Tubes in Anodized Aluminum.	1,652.00
	WHO2A-AL-17	19 3/4"	16 to 17 ft	11 1/2"	Approx 7 lbs per ft	Double shelf hanger style wall rack with silver anodized aluminum shelf tubes, powder coated steel brackets and 1" o.d. stainless steel hanger rod on lower shelf and 7 brackets	Brackets in Medium Gray, Sandstone, Black, Lunar White or Bronze Metallic. Shelf Tubes in Anodized Aluminum.	1,769.00
	WHO2A-AL-18	19 3/4"	17 to 18 ft	11 1/2"	Approx 7 lbs per ft	Double shelf hanger style wall rack with silver anodized aluminum shelf tubes, powder coated steel brackets and 1" o.d. stainless steel hanger rod on lower shelf and 7 brackets	Brackets in Medium Gray, Sandstone, Black, Lunar White or Bronze Metallic. Shelf Tubes in Anodized Aluminum.	1,884.00
	WHO2A-AL-19	19 3/4"	18 to 19 ft	11 1/2"	Approx 7 lbs per ft	Double shelf hanger style wall rack with silver anodized aluminum shelf tubes, powder coated steel brackets and 1" o.d. stainless steel hanger rod on lower shelf and 7 brackets	Brackets in Medium Gray, Sandstone, Black, Lunar White or Bronze Metallic. Shelf Tubes in Anodized Aluminum.	1,999.00
	WHO2A-AL-20	19 3/4"	19 to 20 ft	11 1/2"	Approx 7 lbs per ft	Double shelf hanger style wall rack with silver anodized aluminum shelf tubes, powder coated steel brackets and 1" o.d. stainless steel hanger rod on lower shelf and 7 brackets	Brackets in Medium Gray, Sandstone, Black, Lunar White or Bronze Metallic. Shelf Tubes in Anodized Aluminum.	2,120.00
	WHO2A-OK-2	19 3/4"	1 to 2 ft	11 1/2"	Approx 7 lbs per ft	Double shelf hanger style wall rack with 3/4" square oak shelf bars, powder coated steel brackets and 1" o.d. stainless steel hanger rod on lower shelf and 2 brackets	Brackets in Medium Gray, Sandstone, Black, Lunar White or Bronze Metallic. Shelf Tubes in Natural Oak.	456.00
	WHO2A-OK-3	19 3/4"	2 to 3 ft	11 1/2"	Approx 7 lbs per ft	Double shelf hanger style wall rack with 3/4" square oak shelf bars, powder coated steel brackets and 1" o.d. stainless steel hanger rod on lower shelf and 2 brackets	Brackets in Medium Gray, Sandstone, Black, Lunar White or Bronze Metallic. Shelf Tubes in Natural Oak.	520.00
	WHO2A-OK-4	19 3/4"	3 to 4 ft	11 1/2"	Approx 7 lbs per ft	Double shelf hanger style wall rack with 3/4" square oak shelf bars, powder coated steel brackets and 1" o.d. stainless steel hanger rod on lower shelf and 2 brackets	Brackets in Medium Gray, Sandstone, Black, Lunar White or Bronze Metallic. Shelf Tubes in Natural Oak.	612.00
	WHO2A-OK-5	19 3/4"	4 to 5 ft	11 1/2"	Approx 7 lbs per ft	Double shelf hanger style wall rack with 3/4" square oak shelf bars, powder coated steel brackets and 1" o.d. stainless steel hanger rod on lower shelf and 3 brackets	Brackets in Medium Gray, Sandstone, Black, Lunar White or Bronze Metallic. Shelf Tubes in Natural Oak.	793.00
	WHO2A-OK-6	19 3/4"	5 to 6 ft	11 1/2"	Approx 7 lbs per ft	Double shelf hanger style wall rack with 3/4" square oak shelf bars, powder coated steel brackets and 1" o.d. stainless steel hanger rod on lower shelf and 3 brackets	Brackets in Medium Gray, Sandstone, Black, Lunar White or Bronze Metallic. Shelf Tubes in Natural Oak.	856.00

	WHO2A-OK-7	19 3/4"	6 to 7 ft	11 1/2"	Approx 7 lbs per ft	Double shelf hanger style wall rack with 3/4" square oak shelf bars, powder coated steel brackets and 1" o.d. stainless steel hanger rod on lower shelf and 3 brackets	Brackets in Medium Gray, Sandstone, Black, Lunar White or Bronze Metallic. Shelf Tubes in Natural Oak.	982.00
	WHO2A-OK-8	19 3/4"	7 to 8 ft	11 1/2"	Approx 7 lbs per ft	Double shelf hanger style wall rack with 3/4" square oak shelf bars, powder coated steel brackets and 1" o.d. stainless steel hanger rod on lower shelf and 4 brackets	Brackets in Medium Gray, Sandstone, Black, Lunar White or Bronze Metallic. Shelf Tubes in Natural Oak.	1,079.00
	WHO2A-OK-9	19 3/4"	8 to 9 ft	11 1/2"	Approx 7 lbs per ft	Double shelf hanger style wall rack with 3/4" square oak shelf bars, powder coated steel brackets and 1" o.d. stainless steel hanger rod on lower shelf and 4 brackets	Brackets in Medium Gray, Sandstone, Black, Lunar White or Bronze Metallic. Shelf Tubes in Natural Oak.	1,231.00
	WHO2A-OK-10	19 3/4"	9 to 10 ft	11 1/2"	Approx 7 lbs per ft	Double shelf hanger style wall rack with 3/4" square oak shelf bars, powder coated steel brackets and 1" o.d. stainless steel hanger rod on lower shelf and 4 brackets	Brackets in Medium Gray, Sandstone, Black, Lunar White or Bronze Metallic. Shelf Tubes in Natural Oak.	1,317.00
	WHO2A-OK-11	19 3/4"	10 to 11 ft	11 1/2"	Approx 7 lbs per ft	Double shelf hanger style wall rack with 3/4" square oak shelf bars, powder coated steel brackets and 1" o.d. stainless steel hanger rod on lower shelf and 5 brackets	Brackets in Medium Gray, Sandstone, Black, Lunar White or Bronze Metallic. Shelf Tubes in Natural Oak.	1,444.00
	WHO2A-OK-12	19 3/4"	11 to 12 ft	11 1/2"	Approx 7 lbs per ft	Double shelf hanger style wall rack with 3/4" square oak shelf bars, powder coated steel brackets and 1" o.d. stainless steel hanger rod on lower shelf and 5 brackets	Brackets in Medium Gray, Sandstone, Black, Lunar White or Bronze Metallic. Shelf Tubes in Natural Oak.	1,560.00
	WHO2A-OK-13	19 3/4"	12 to 13 ft	11 1/2"	Approx 7 lbs per ft	Double shelf hanger style wall rack with 3/4" square oak shelf bars, powder coated steel brackets and 1" o.d. stainless steel hanger rod on lower shelf and 5 brackets	Brackets in Medium Gray, Sandstone, Black, Lunar White or Bronze Metallic. Shelf Tubes in Natural Oak.	1,773.00
	WHO2A-OK-14	19 3/4"	13 to 14 ft	11 1/2"	Approx 7 lbs per ft	Double shelf hanger style wall rack with 3/4" square oak shelf bars, powder coated steel brackets and 1" o.d. stainless steel hanger rod on lower shelf and 6 brackets	Brackets in Medium Gray, Sandstone, Black, Lunar White or Bronze Metallic. Shelf Tubes in Natural Oak.	1,973.00
	WHO2A-OK-15	19 3/4"	14 to 15 ft	11 1/2"	Approx 7 lbs per ft	Double shelf hanger style wall rack with 3/4" square oak shelf bars, powder coated steel brackets and 1" o.d. stainless steel hanger rod on lower shelf and 6 brackets	Brackets in Medium Gray, Sandstone, Black, Lunar White or Bronze Metallic. Shelf Tubes in Natural Oak.	2,087.00
	WHO2A-OK-16	19 3/4"	15 to 16 ft	11 1/2"	Approx 7 lbs per ft	Double shelf hanger style wall rack with 3/4" square oak shelf bars, powder coated steel brackets and 1" o.d. stainless steel hanger rod on lower shelf and 6 brackets	Brackets in Medium Gray, Sandstone, Black, Lunar White or Bronze Metallic. Shelf Tubes in Natural Oak.	2,287.00
	WHO2A-OK-17	19 3/4"	16 to 17 ft	11 1/2"	Approx 7 lbs per ft	Double shelf hanger style wall rack with 3/4" square oak shelf bars, powder coated steel brackets and 1" o.d. stainless steel hanger rod on lower shelf and 7 brackets	Brackets in Medium Gray, Sandstone, Black, Lunar White or Bronze Metallic. Shelf Tubes in Natural Oak.	2,429.00
	WHO2A-OK-18	19 3/4"	17 to 18 ft	11 1/2"	Approx 7 lbs per ft	Double shelf hanger style wall rack with 3/4" square oak shelf bars, powder coated steel brackets and 1" o.d. stainless steel hanger rod on lower shelf and 7 brackets	Brackets in Medium Gray, Sandstone, Black, Lunar White or Bronze Metallic. Shelf Tubes in Natural Oak.	2,571.00
	WHO2A-OK-19	19 3/4"	18 to 19 ft	11 1/2"	Approx 7 lbs per ft	Double shelf hanger style wall rack with 3/4" square oak shelf bars, powder coated steel brackets and 1" o.d. stainless steel hanger rod on lower shelf and 7 brackets	Brackets in Medium Gray, Sandstone, Black, Lunar White or Bronze Metallic. Shelf Tubes in Natural Oak.	2,712.00



WHO2A-OK-20

19 3/4"

19 to 20 ft

11 1/2"

Approx 7
lbs per ft

Double shelf hanger style wall rack with 3/4" square oak shelf bars, powder coated steel brackets and 1" o.d. stainless steel hanger rod on lower shelf and 7 brackets

Brackets in Medium Gray, Sandstone, Black, Lunar White or Bronze Metallic. Shelf Tubes in Natural Oak.

2,869.00

VILLA HOOK WALL RACK (WK01A)

BRACKET FINISH COLORS



Medium Grey Black Sandstone Lunar White Bronze Metallic

SHELF TUBE FINISH COLORS



Medium Grey Black Sandstone Lunar White Bronze Metallic



Anodized Aluminum

HOOK FINISH COLORS



Charcoal Grey Sandstone Black

HOW TO ORDER



Determine Hook Rail Width/Model #1
Select Shelf Tube Material/Color #2
Select Bracket, Rail & Hook Color #3

Example Order: WK01A-ST-13 in Bronze Metallic with Black Hooks - 12' 3" wide WK01A Wall Rack in Bronze Metallic with Black Hooks.

ADDITIONAL NOTES

CUSTOM WIDTH & PRICING

Villa Wall Racks are made to order with custom widths available to the nearest whole inch. Magnuson Group does not size to fractional inches (i.e. 12' 8 3/4" wide would be instead cut to 12' 8" wide).

When determining the model that corresponds to the custom width specified, round up to the nearest foot. For example, a 12' 3" wide WK01A unit would be priced using model WK01A-13 - this pricing would be the same for any WK01A unit with a width between 12' 1" and 13'.

MITRED CORNERS

For continuous shelving in L or U shaped wall configurations, Mitred Corners are available. Exact dimensions of each wall are required for pricing.

\$105.00 per corner per shelf.

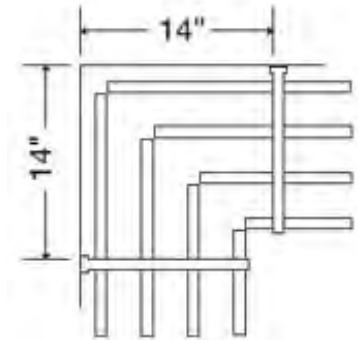

ADDITIONAL NOTES

Ships UPS where possible, otherwise Common Carrier is used.

Custom Villa WK01A units include triple prong hooks secured to 2nd and 4th tubes from the front.









For pricing on longer lengths, contact Customer Service.









Sample chips available.









Submittal drawings available upon request.









Hardware to secure the mounting brackets to the wall is not included due to the variety of possible surface applications.







LINE ART	MODEL	H	W	D	WEIGHT	DESCRIPTION	COLOR/FINISH	LIST PRICE
	WK01A-ST-2	13 1/2"	1 to 2 ft	11 1/2"	Approx 4 lbs per ft	Single shelf hook style wall rack in powder coated steel finish with 4 K73 triple prong hooks and 2 brackets	Brackets in Medium Gray, Sandstone, Black, Lunar White or Bronze Metallic. Shelf Tubes in Medium Gray, Sandstone, Black, Lunar White or Bronze Metallic. Hooks in Charcoal Gray, Black or Sandstone.	252.00
	WK01A-ST-3	13 1/2"	2 to 3 ft	11 1/2"	Approx 4 lbs per ft	Single shelf hook style wall rack in powder coated steel finish with 6 K73 triple prong hooks and 2 brackets	Brackets in Medium Gray, Sandstone, Black, Lunar White or Bronze Metallic. Shelf Tubes in Medium Gray, Sandstone, Black, Lunar White or Bronze Metallic. Hooks in Charcoal Gray, Black or Sandstone.	292.00
	WK01A-ST-4	13 1/2"	3 to 4 ft	11 1/2"	Approx 4 lbs per ft	Single shelf hook style wall rack in powder coated steel finish with 8 K73 triple prong hooks and 2 brackets	Brackets in Medium Gray, Sandstone, Black, Lunar White or Bronze Metallic. Shelf Tubes in Medium Gray, Sandstone, Black, Lunar White or Bronze Metallic. Hooks in Charcoal Gray, Black or Sandstone.	348.00
	WK01A-ST-5	13 1/2"	4 to 5 ft	11 1/2"	Approx 4 lbs per ft	Single shelf hook style wall rack in powder coated steel finish with 12 K73 triple prong hooks and 3 brackets	Brackets in Medium Gray, Sandstone, Black, Lunar White or Bronze Metallic. Shelf Tubes in Medium Gray, Sandstone, Black, Lunar White or Bronze Metallic. Hooks in Charcoal Gray, Black or Sandstone.	414.00
	WK01A-ST-6	13 1/2"	5 to 6 ft	11 1/2"	Approx 4 lbs per ft	Single shelf hook style wall rack in powder coated steel finish with 16 K73 triple prong hooks and 3 brackets	Brackets in Medium Gray, Sandstone, Black, Lunar White or Bronze Metallic. Shelf Tubes in Medium Gray, Sandstone, Black, Lunar White or Bronze Metallic. Hooks in Charcoal Gray, Black or Sandstone.	496.00
	WK01A-ST-7	13 1/2"	6 to 7 ft	11 1/2"	Approx 4 lbs per ft	Single shelf hook style wall rack in powder coated steel finish with 16 K73 triple prong hooks and 3 brackets	Brackets in Medium Gray, Sandstone, Black, Lunar White or Bronze Metallic. Shelf Tubes in Medium Gray, Sandstone, Black, Lunar White or Bronze Metallic. Hooks in Charcoal Gray, Black or Sandstone.	527.00
	WK01A-ST-8	13 1/2"	7 to 8 ft	11 1/2"	Approx 4 lbs per ft	Single shelf hook style wall rack in powder coated steel finish with 18 K73 triple prong hooks and 4 brackets	Brackets in Medium Gray, Sandstone, Black, Lunar White or Bronze Metallic. Shelf Tubes in Medium Gray, Sandstone, Black, Lunar White or Bronze Metallic. Hooks in Charcoal Gray, Black or Sandstone.	602.00
	WK01A-ST-9	13 1/2"	8 to 9 ft	11 1/2"	Approx 4 lbs per ft	Single shelf hook style wall rack in powder coated steel finish with 24 K73 triple prong hooks and 4 brackets	Brackets in Medium Gray, Sandstone, Black, Lunar White or Bronze Metallic. Shelf Tubes in Medium Gray, Sandstone, Black, Lunar White or Bronze Metallic. Hooks in Charcoal Gray, Black or Sandstone.	665.00

	WK01A-ST-10	13 1/2"	9 to 10 ft	11 1/2"	Approx 4 lbs per ft	Single shelf hook style wall rack in powder coated steel finish with 24 K73 triple prong hooks and 4 brackets	Brackets in Medium Gray, Sandstone, Black, Lunar White or Bronze Metallic. Shelf Tubes in Medium Gray, Sandstone, Black, Lunar White or Bronze Metallic. Hooks in Charcoal Gray, Black or Sandstone.	720.00
	WK01A-ST-11	13 1/2"	10 to 11 ft	11 1/2"	Approx 4 lbs per ft	Single shelf hook style wall rack in powder coated steel finish with 32 K73 triple prong hooks and 5 brackets	Brackets in Medium Gray, Sandstone, Black, Lunar White or Bronze Metallic. Shelf Tubes in Medium Gray, Sandstone, Black, Lunar White or Bronze Metallic. Hooks in Charcoal Gray, Black or Sandstone.	834.00
	WK01A-ST-12	13 1/2"	11 to 12 ft	11 1/2"	Approx 4 lbs per ft	Single shelf hook style wall rack in powder coated steel finish with 32 K73 triple prong hooks and 5 brackets	Brackets in Medium Gray, Sandstone, Black, Lunar White or Bronze Metallic. Shelf Tubes in Medium Gray, Sandstone, Black, Lunar White or Bronze Metallic. Hooks in Charcoal Gray, Black or Sandstone.	873.00
	WK01A-ST-13	13 1/2"	12 to 13 ft	11 1/2"	Approx 4 lbs per ft	Single shelf hook style wall rack in powder coated steel finish with 32 K73 triple prong hooks and 5 brackets	Brackets in Medium Gray, Sandstone, Black, Lunar White or Bronze Metallic. Shelf Tubes in Medium Gray, Sandstone, Black, Lunar White or Bronze Metallic. Hooks in Charcoal Gray, Black or Sandstone.	951.00
	WK01A-ST-14	13 1/2"	13 to 14 ft	11 1/2"	Approx 4 lbs per ft	Single shelf hook style wall rack in powder coated steel finish with 40 K73 triple prong hooks and 6 brackets	Brackets in Medium Gray, Sandstone, Black, Lunar White or Bronze Metallic. Shelf Tubes in Medium Gray, Sandstone, Black, Lunar White or Bronze Metallic. Hooks in Charcoal Gray, Black or Sandstone.	1,050.00
	WK01A-ST-15	13 1/2"	14 to 15 ft	11 1/2"	Approx 4 lbs per ft	Single shelf hook style wall rack in powder coated steel finish with 40 K73 triple prong hooks and 6 brackets	Brackets in Medium Gray, Sandstone, Black, Lunar White or Bronze Metallic. Shelf Tubes in Medium Gray, Sandstone, Black, Lunar White or Bronze Metallic. Hooks in Charcoal Gray, Black or Sandstone.	1,130.00
	WK01A-ST-16	13 1/2"	15 to 16 ft	11 1/2"	Approx 4 lbs per ft	Single shelf hook style wall rack in powder coated steel finish with 40 K73 triple prong hooks and 6 brackets	Brackets in Medium Gray, Sandstone, Black, Lunar White or Bronze Metallic. Shelf Tubes in Medium Gray, Sandstone, Black, Lunar White or Bronze Metallic. Hooks in Charcoal Gray, Black or Sandstone.	1,166.00
	WK01A-ST-17	13 1/2"	16 to 17 ft	11 1/2"	Approx 4 lbs per ft	Single shelf hook style wall rack in powder coated steel finish with 48 K73 triple prong hooks and 7 brackets	Brackets in Medium Gray, Sandstone, Black, Lunar White or Bronze Metallic. Shelf Tubes in Medium Gray, Sandstone, Black, Lunar White or Bronze Metallic. Hooks in Charcoal Gray, Black or Sandstone.	1,230.00

	WK01A-ST-18	13 1/2"	17 to 18 ft	11 1/2"	Approx 4 lbs per ft	Single shelf hook style wall rack in powder coated steel finish with 48 K73 triple prong hooks and 7 brackets	Brackets in Medium Gray, Sandstone, Black, Lunar White or Bronze Metallic. Shelf Tubes in Medium Gray, Sandstone, Black, Lunar White or Bronze Metallic. Hooks in Charcoal Gray, Black or Sandstone.	1,298.00
	WK01A-ST-19	13 1/2"	18 to 19 ft	11 1/2"	Approx 4 lbs per ft	Single shelf hook style wall rack in powder coated steel finish with 48 K73 triple prong hooks and 7 brackets	Brackets in Medium Gray, Sandstone, Black, Lunar White or Bronze Metallic. Shelf Tubes in Medium Gray, Sandstone, Black, Lunar White or Bronze Metallic. Hooks in Charcoal Gray, Black or Sandstone.	1,361.00
	WK01A-ST-20	13 1/2"	19 to 20 ft	11 1/2"	Approx 4 lbs per ft	Single shelf hook style wall rack in powder coated steel finish with 48 K73 triple prong hooks and 7 brackets	Brackets in Medium Gray, Sandstone, Black, Lunar White or Bronze Metallic. Shelf Tubes in Medium Gray, Sandstone, Black, Lunar White or Bronze Metallic. Hooks in Charcoal Gray, Black or Sandstone.	1,428.00
	WK01A-AL-2	13 1/2"	1 to 2 ft	11 1/2"	Approx 4 lbs per ft	Single shelf hook style wall rack with silver anodized aluminum shelf tubes, 2 brackets in powder coated steel and 4 K73 triple prong hooks	Brackets in Medium Gray, Sandstone, Black, Lunar White or Bronze Metallic. Shelf Tubes in Anodized Aluminum. Hooks in Charcoal Gray, Black or Sandstone.	287.00
	WK01A-AL-3	13 1/2"	2 to 3 ft	11 1/2"	Approx 4 lbs per ft	Single shelf hook style wall rack with silver anodized aluminum shelf tubes, 2 brackets in powder coated steel and 6 K73 triple prong hooks	Brackets in Medium Gray, Sandstone, Black, Lunar White or Bronze Metallic. Shelf Tubes in Anodized Aluminum. Hooks in Charcoal Gray, Black or Sandstone.	325.00
	WK01A-AL-4	13 1/2"	3 to 4 ft	11 1/2"	Approx 4 lbs per ft	Single shelf hook style wall rack with silver anodized aluminum shelf tubes, 2 brackets in powder coated steel and 8 K73 triple prong hooks	Brackets in Medium Gray, Sandstone, Black, Lunar White or Bronze Metallic. Shelf Tubes in Anodized Aluminum. Hooks in Charcoal Gray, Black or Sandstone.	377.00
	WK01A-AL-5	13 1/2"	4 to 5 ft	11 1/2"	Approx 4 lbs per ft	Single shelf hook style wall rack with silver anodized aluminum shelf tubes, 3 brackets in powder coated steel and 12 K73 triple prong hooks	Brackets in Medium Gray, Sandstone, Black, Lunar White or Bronze Metallic. Shelf Tubes in Anodized Aluminum. Hooks in Charcoal Gray, Black or Sandstone.	437.00
	WK01A-AL-6	13 1/2"	5 to 6 ft	11 1/2"	Approx 4 lbs per ft	Single shelf hook style wall rack with silver anodized aluminum shelf tubes, 3 brackets in powder coated steel and 16 K73 triple prong hooks	Brackets in Medium Gray, Sandstone, Black, Lunar White or Bronze Metallic. Shelf Tubes in Anodized Aluminum. Hooks in Charcoal Gray, Black or Sandstone.	558.00
	WK01A-AL-7	13 1/2"	6 to 7 ft	11 1/2"	Approx 4 lbs per ft	Single shelf hook style wall rack with silver anodized aluminum shelf tubes, 3 brackets in powder coated steel and 16 K73 triple prong hooks	Brackets in Medium Gray, Sandstone, Black, Lunar White or Bronze Metallic. Shelf Tubes in Anodized Aluminum. Hooks in Charcoal Gray, Black or Sandstone.	588.00

	WK01A-AL-8	13 1/2"	7 to 8 ft	11 1/2"	Approx 4 lbs per ft	Single shelf hook style wall rack with silver anodized aluminum shelf tubes, 4 brackets in powder coated steel and 18 K73 triple prong hooks	Brackets in Medium Gray, Sandstone, Black, Lunar White or Bronze Metallic. Shelf Tubes in Anodized Aluminum. Hooks in Charcoal Gray, Black or Sandstone.	633.00
	WK01A-AL-9	13 1/2"	8 to 9 ft	11 1/2"	Approx 4 lbs per ft	Single shelf hook style wall rack with silver anodized aluminum shelf tubes, 4 brackets in powder coated steel and 24 K73 triple prong hooks	Brackets in Medium Gray, Sandstone, Black, Lunar White or Bronze Metallic. Shelf Tubes in Anodized Aluminum. Hooks in Charcoal Gray, Black or Sandstone.	720.00
	WK01A-AL-10	13 1/2"	9 to 10 ft	11 1/2"	Approx 4 lbs per ft	Single shelf hook style wall rack with silver anodized aluminum shelf tubes, 4 brackets in powder coated steel and 24 K73 triple prong hooks	Brackets in Medium Gray, Sandstone, Black, Lunar White or Bronze Metallic. Shelf Tubes in Anodized Aluminum. Hooks in Charcoal Gray, Black or Sandstone.	756.00
	WK01A-AL-11	13 1/2"	10 to 11 ft	11 1/2"	Approx 4 lbs per ft	Single shelf hook style wall rack with silver anodized aluminum shelf tubes, 5 brackets in powder coated steel and 32 K73 triple prong hooks	Brackets in Medium Gray, Sandstone, Black, Lunar White or Bronze Metallic. Shelf Tubes in Anodized Aluminum. Hooks in Charcoal Gray, Black or Sandstone.	858.00
	WK01A-AL-12	13 1/2"	11 to 12 ft	11 1/2"	Approx 4 lbs per ft	Single shelf hook style wall rack with silver anodized aluminum shelf tubes, 5 brackets in powder coated steel and 32 K73 triple prong hooks	Brackets in Medium Gray, Sandstone, Black, Lunar White or Bronze Metallic. Shelf Tubes in Anodized Aluminum. Hooks in Charcoal Gray, Black or Sandstone.	934.00
	WK01A-AL-13	13 1/2"	12 to 13 ft	11 1/2"	Approx 4 lbs per ft	Single shelf hook style wall rack with silver anodized aluminum shelf tubes, 5 brackets in powder coated steel and 32 K73 triple prong hooks	Brackets in Medium Gray, Sandstone, Black, Lunar White or Bronze Metallic. Shelf Tubes in Anodized Aluminum. Hooks in Charcoal Gray, Black or Sandstone.	996.00
	WK01A-AL-14	13 1/2"	13 to 14 ft	11 1/2"	Approx 4 lbs per ft	Single shelf hook style wall rack with silver anodized aluminum shelf tubes, 6 brackets in powder coated steel and 40 K73 triple prong hooks	Brackets in Medium Gray, Sandstone, Black, Lunar White or Bronze Metallic. Shelf Tubes in Anodized Aluminum. Hooks in Charcoal Gray, Black or Sandstone.	1,087.00
	WK01A-AL-15	13 1/2"	14 to 15 ft	11 1/2"	Approx 4 lbs per ft	Single shelf hook style wall rack with silver anodized aluminum shelf tubes, 6 brackets in powder coated steel and 40 K73 triple prong hooks	Brackets in Medium Gray, Sandstone, Black, Lunar White or Bronze Metallic. Shelf Tubes in Anodized Aluminum. Hooks in Charcoal Gray, Black or Sandstone.	1,166.00
	WK01A-AL-16	13 1/2"	15 to 16 ft	11 1/2"	Approx 4 lbs per ft	Single shelf hook style wall rack with silver anodized aluminum shelf tubes, 6 brackets in powder coated steel and 40 K73 triple prong hooks	Brackets in Medium Gray, Sandstone, Black, Lunar White or Bronze Metallic. Shelf Tubes in Anodized Aluminum. Hooks in Charcoal Gray, Black or Sandstone.	1,221.00

	WK01A-AL-17	13 1/2"	16 to 17 ft	11 1/2"	Approx 4 lbs per ft	Single shelf hook style wall rack with silver anodized aluminum shelf tubes, 7 brackets in powder coated steel and 48 K73 triple prong hooks	Brackets in Medium Gray, Sandstone, Black, Lunar White or Bronze Metallic. Shelf Tubes in Anodized Aluminum. Hooks in Charcoal Gray, Black or Sandstone.	1,291.00
	WK01A-AL-18	13 1/2"	17 to 18 ft	11 1/2"	Approx 4 lbs per ft	Single shelf hook style wall rack with silver anodized aluminum shelf tubes, 7 brackets in powder coated steel and 48 K73 triple prong hooks	Brackets in Medium Gray, Sandstone, Black, Lunar White or Bronze Metallic. Shelf Tubes in Anodized Aluminum. Hooks in Charcoal Gray, Black or Sandstone.	1,361.00
	WK01A-AL-19	13 1/2"	18 to 19 ft	11 1/2"	Approx 4 lbs per ft	Single shelf hook style wall rack with silver anodized aluminum shelf tubes, 7 brackets in powder coated steel and 48 K73 triple prong hooks	Brackets in Medium Gray, Sandstone, Black, Lunar White or Bronze Metallic. Shelf Tubes in Anodized Aluminum. Hooks in Charcoal Gray, Black or Sandstone.	1,433.00
	WK01A-AL-20	13 1/2"	19 to 20 ft	11 1/2"	Approx 4 lbs per ft	Single shelf hook style wall rack with silver anodized aluminum shelf tubes, 7 brackets in powder coated steel and 48 K73 triple prong hooks	Brackets in Medium Gray, Sandstone, Black, Lunar White or Bronze Metallic. Shelf Tubes in Anodized Aluminum. Hooks in Charcoal Gray, Black or Sandstone.	1,507.00

VILLA DOUBLE HOOK WALL RACK (WK02A)

BRACKET FINISH COLORS



Medium Grey Black Sandstone Lunar White Bronze Metallic

HOOK FINISH COLORS



Charcoal Grey Sandstone Black

SHELF TUBE FINISH COLORS



Medium Grey Black Sandstone Lunar White Bronze Metallic



Anodized Aluminum

HOW TO ORDER



Determine Hook Rail Width/Model #1
Select Shelf Tube Material/Color #2
Select Bracket, Rail & Hook Color #3

Example Order: WK02A-AL-14 in Lunar White with Charcoal Grey Hooks - 13' 11" wide WK02A Wall Rack in Lunar White with Anodized Aluminum Shelf Tubes and Charcoal Grey Hooks.

ADDITIONAL NOTES

CUSTOM WIDTH & PRICING

Villa Wall Racks are made to order with custom widths available to the nearest whole inch. Magnuson Group does not size to fractional inches (i.e. 12' 8 3/4" wide would be instead cut to 12' 8" wide).

When determining the model that corresponds to the custom width specified, round up to the nearest foot. For example, a 12' 3" wide WK02A unit would be priced using model WK02A-13 - this pricing would be the same for any WK02A unit with a width between 12' 1" and 13'.

MITRED CORNERS

For continuous shelving in L or U shaped wall configurations, Mitred Corners are available. Exact dimensions of each wall are required for pricing.

\$105.00 per corner per shelf.

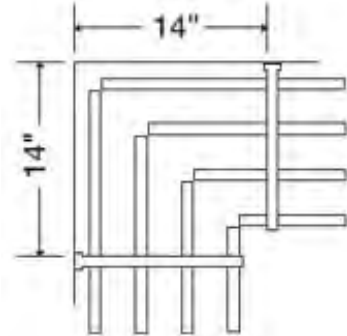

ADDITIONAL NOTES

Ships UPS where possible, otherwise Common Carrier is used.

Custom Villa WK02A units include triple prong hooks secured to 2nd and 4th tubes from the front on lower shelf.









For pricing on longer lengths, contact Customer Service.









Sample chips available.









Submittal drawings available upon request.









Hardware to secure the mounting brackets to the wall is not included due to the variety of possible surface applications.







LINE ART	MODEL	H	W	D	WEIGHT	DESCRIPTION	COLOR/FINISH	LIST PRICE
	WK02A-ST-2	19 3/4"	1 to 2 ft	11 1/2"	Approx 7 lbs per ft	Double shelf hook style wall rack in powder coated steel finish with 4 K73 triple prong hooks and 2 brackets	Brackets in Medium Gray, Sandstone, Black, Lunar White or Bronze Metallic. Shelf Tubes in Medium Gray, Sandstone, Black, Lunar White or Bronze Metallic. Hooks in Charcoal Gray, Black or Sandstone.	393.00
	WK02A-ST-3	19 3/4"	2 to 3 ft	11 1/2"	Approx 7 lbs per ft	Double shelf hook style wall rack in powder coated steel finish with 6 K73 triple prong hooks and 2 brackets	Brackets in Medium Gray, Sandstone, Black, Lunar White or Bronze Metallic. Shelf Tubes in Medium Gray, Sandstone, Black, Lunar White or Bronze Metallic. Hooks in Charcoal Gray, Black or Sandstone.	495.00
	WK02A-ST-4	19 3/4"	3 to 4 ft	11 1/2"	Approx 7 lbs per ft	Double shelf hook style wall rack in powder coated steel finish with 8 K73 triple prong hooks and 2 brackets	Brackets in Medium Gray, Sandstone, Black, Lunar White or Bronze Metallic. Shelf Tubes in Medium Gray, Sandstone, Black, Lunar White or Bronze Metallic. Hooks in Charcoal Gray, Black or Sandstone.	522.00
	WK02A-ST-5	19 3/4"	4 to 5 ft	11 1/2"	Approx 7 lbs per ft	Double shelf hook style wall rack in powder coated steel finish with 12 K73 triple prong hooks and 3 brackets	Brackets in Medium Gray, Sandstone, Black, Lunar White or Bronze Metallic. Shelf Tubes in Medium Gray, Sandstone, Black, Lunar White or Bronze Metallic. Hooks in Charcoal Gray, Black or Sandstone.	638.00
	WK02A-ST-6	19 3/4"	5 to 6 ft	11 1/2"	Approx 7 lbs per ft	Double shelf hook style wall rack in powder coated steel finish with 16 K73 triple prong hooks and 3 brackets	Brackets in Medium Gray, Sandstone, Black, Lunar White or Bronze Metallic. Shelf Tubes in Medium Gray, Sandstone, Black, Lunar White or Bronze Metallic. Hooks in Charcoal Gray, Black or Sandstone.	709.00
	WK02A-ST-7	19 3/4"	6 to 7 ft	11 1/2"	Approx 7 lbs per ft	Double shelf hook style wall rack in powder coated steel finish with 16 K73 triple prong hooks and 3 brackets	Brackets in Medium Gray, Sandstone, Black, Lunar White or Bronze Metallic. Shelf Tubes in Medium Gray, Sandstone, Black, Lunar White or Bronze Metallic. Hooks in Charcoal Gray, Black or Sandstone.	779.00
	WK02A-ST-8	19 3/4"	7 to 8 ft	11 1/2"	Approx 7 lbs per ft	Double shelf hook style wall rack in powder coated steel finish with 18 K73 triple prong hooks and 4 brackets	Brackets in Medium Gray, Sandstone, Black, Lunar White or Bronze Metallic. Shelf Tubes in Medium Gray, Sandstone, Black, Lunar White or Bronze Metallic. Hooks in Charcoal Gray, Black or Sandstone.	900.00
	WK02A-ST-9	19 3/4"	8 to 9 ft	11 1/2"	Approx 7 lbs per ft	Double shelf hook style wall rack in powder coated steel finish with 24 K73 triple prong hooks and 4 brackets	Brackets in Medium Gray, Sandstone, Black, Lunar White or Bronze Metallic. Shelf Tubes in Medium Gray, Sandstone, Black, Lunar White or Bronze Metallic. Hooks in Charcoal Gray, Black or Sandstone.	1,032.00

	WKO2A-ST-10	19 3/4"	9 to 10 ft	11 1/2"	Approx 7 lbs per ft	Double shelf hook style wall rack in powder coated steel finish with 24 K73 triple prong hooks and 4 brackets	Brackets in Medium Gray, Sandstone, Black, Lunar White or Bronze Metallic. Shelf Tubes in Medium Gray, Sandstone, Black, Lunar White or Bronze Metallic. Hooks in Charcoal Gray, Black or Sandstone.	1,086.00
	WKO2A-ST-11	19 3/4"	10 to 11 ft	11 1/2"	Approx 7 lbs per ft	Double shelf hook style wall rack in powder coated steel finish with 32 K73 triple prong hooks and 5 brackets	Brackets in Medium Gray, Sandstone, Black, Lunar White or Bronze Metallic. Shelf Tubes in Medium Gray, Sandstone, Black, Lunar White or Bronze Metallic. Hooks in Charcoal Gray, Black or Sandstone.	1,197.00
	WKO2A-ST-12	19 3/4"	11 to 12 ft	11 1/2"	Approx 7 lbs per ft	Double shelf hook style wall rack in powder coated steel finish with 32 K73 triple prong hooks and 5 brackets	Brackets in Medium Gray, Sandstone, Black, Lunar White or Bronze Metallic. Shelf Tubes in Medium Gray, Sandstone, Black, Lunar White or Bronze Metallic. Hooks in Charcoal Gray, Black or Sandstone.	1,339.00
	WKO2A-ST-13	19 3/4"	12 to 13 ft	11 1/2"	Approx 7 lbs per ft	Double shelf hook style wall rack in powder coated steel finish with 32 K73 triple prong hooks and 5 brackets	Brackets in Medium Gray, Sandstone, Black, Lunar White or Bronze Metallic. Shelf Tubes in Medium Gray, Sandstone, Black, Lunar White or Bronze Metallic. Hooks in Charcoal Gray, Black or Sandstone.	1,444.00
	WKO2A-ST-14	19 3/4"	13 to 14 ft	11 1/2"	Approx 7 lbs per ft	Double shelf hook style wall rack in powder coated steel finish with 40 K73 triple prong hooks and 6 brackets	Brackets in Medium Gray, Sandstone, Black, Lunar White or Bronze Metallic. Shelf Tubes in Medium Gray, Sandstone, Black, Lunar White or Bronze Metallic. Hooks in Charcoal Gray, Black or Sandstone.	1,549.00
	WKO2A-ST-15	19 3/4"	14 to 15 ft	11 1/2"	Approx 7 lbs per ft	Double shelf hook style wall rack in powder coated steel finish with 40 K73 triple prong hooks and 6 brackets	Brackets in Medium Gray, Sandstone, Black, Lunar White or Bronze Metallic. Shelf Tubes in Medium Gray, Sandstone, Black, Lunar White or Bronze Metallic. Hooks in Charcoal Gray, Black or Sandstone.	1,643.00
	WKO2A-ST-16	19 3/4"	15 to 16 ft	11 1/2"	Approx 7 lbs per ft	Double shelf hook style wall rack in powder coated steel finish with 40 K73 triple prong hooks and 6 brackets	Brackets in Medium Gray, Sandstone, Black, Lunar White or Bronze Metallic. Shelf Tubes in Medium Gray, Sandstone, Black, Lunar White or Bronze Metallic. Hooks in Charcoal Gray, Black or Sandstone.	1,770.00
	WKO2A-ST-17	19 3/4"	16 to 17 ft	11 1/2"	Approx 7 lbs per ft	Double shelf hook style wall rack in powder coated steel finish with 48 K73 triple prong hooks and 7 brackets	Brackets in Medium Gray, Sandstone, Black, Lunar White or Bronze Metallic. Shelf Tubes in Medium Gray, Sandstone, Black, Lunar White or Bronze Metallic. Hooks in Charcoal Gray, Black or Sandstone.	1,880.00

	WKO2A-ST-18	19 3/4"	17 to 18 ft	11 1/2"	Approx 7 lbs per ft	Double shelf hook style wall rack in powder coated steel finish with 48 K73 triple prong hooks and 7 brackets	Brackets in Medium Gray, Sandstone, Black, Lunar White or Bronze Metallic. Shelf Tubes in Medium Gray, Sandstone, Black, Lunar White or Bronze Metallic. Hooks in Charcoal Gray, Black or Sandstone.	1,990.00
	WKO2A-ST-19	19 3/4"	18 to 19 ft	11 1/2"	Approx 7 lbs per ft	Double shelf hook style wall rack in powder coated steel finish with 48 K73 triple prong hooks and 7 brackets	Brackets in Medium Gray, Sandstone, Black, Lunar White or Bronze Metallic. Shelf Tubes in Medium Gray, Sandstone, Black, Lunar White or Bronze Metallic. Hooks in Charcoal Gray, Black or Sandstone.	2,093.00
	WKO2A-ST-20	19 3/4"	19 to 20 ft	11 1/2"	Approx 7 lbs per ft	Double shelf hook style wall rack in powder coated steel finish with 48 K73 triple prong hooks and 7 brackets	Brackets in Medium Gray, Sandstone, Black, Lunar White or Bronze Metallic. Shelf Tubes in Medium Gray, Sandstone, Black, Lunar White or Bronze Metallic. Hooks in Charcoal Gray, Black or Sandstone.	2,201.00
	WKO2A-AL-2	19 3/4"	1 to 2 ft	11 1/2"	Approx 7 lbs per ft	Double shelf hook style wall rack with silver anodized aluminum shelf tubes, 2 brackets in powder coated steel and 4 K73 triple prong hooks	Brackets in Medium Gray, Sandstone, Black, Lunar White or Bronze Metallic. Shelf Tubes in Anodized Aluminum. Hooks in Charcoal Gray, Black or Sandstone.	485.00
	WKO2A-AL-3	19 3/4"	2 to 3 ft	11 1/2"	Approx 7 lbs per ft	Double shelf hook style wall rack with silver anodized aluminum shelf tubes, 2 brackets in powder coated steel and 6 K73 triple prong hooks	Brackets in Medium Gray, Sandstone, Black, Lunar White or Bronze Metallic. Shelf Tubes in Anodized Aluminum. Hooks in Charcoal Gray, Black or Sandstone.	556.00
	WKO2A-AL-4	19 3/4"	3 to 4 ft	11 1/2"	Approx 7 lbs per ft	Double shelf hook style wall rack with silver anodized aluminum shelf tubes, 2 brackets in powder coated steel and 8 K73 triple prong hooks	Brackets in Medium Gray, Sandstone, Black, Lunar White or Bronze Metallic. Shelf Tubes in Anodized Aluminum. Hooks in Charcoal Gray, Black or Sandstone.	577.00
	WKO2A-AL-5	19 3/4"	4 to 5 ft	11 1/2"	Approx 7 lbs per ft	Double shelf hook style wall rack with silver anodized aluminum shelf tubes, 3 brackets in powder coated steel and 12 K73 triple prong hooks	Brackets in Medium Gray, Sandstone, Black, Lunar White or Bronze Metallic. Shelf Tubes in Anodized Aluminum. Hooks in Charcoal Gray, Black or Sandstone.	724.00
	WKO2A-AL-6	19 3/4"	5 to 6 ft	11 1/2"	Approx 7 lbs per ft	Double shelf hook style wall rack with silver anodized aluminum shelf tubes, 3 brackets in powder coated steel and 16 K73 triple prong hooks	Brackets in Medium Gray, Sandstone, Black, Lunar White or Bronze Metallic. Shelf Tubes in Anodized Aluminum. Hooks in Charcoal Gray, Black or Sandstone.	802.00
	WKO2A-AL-7	19 3/4"	6 to 7 ft	11 1/2"	Approx 7 lbs per ft	Double shelf hook style wall rack with silver anodized aluminum shelf tubes, 3 brackets in powder coated steel and 16 K73 triple prong hooks	Brackets in Medium Gray, Sandstone, Black, Lunar White or Bronze Metallic. Shelf Tubes in Anodized Aluminum. Hooks in Charcoal Gray, Black or Sandstone.	890.00

	WKO2A-AL-8	19 3/4"	7 to 8 ft	11 1/2"	Approx 7 lbs per ft	Double shelf hook style wall rack with silver anodized aluminum shelf tubes, 4 brackets in powder coated steel and 18 K73 triple prong hooks	Brackets in Medium Gray, Sandstone, Black, Lunar White or Bronze Metallic. Shelf Tubes in Anodized Aluminum. Hooks in Charcoal Gray, Black or Sandstone.	1,050.00
	WKO2A-AL-9	19 3/4"	8 to 9 ft	11 1/2"	Approx 7 lbs per ft	Double shelf hook style wall rack with silver anodized aluminum shelf tubes, 4 brackets in powder coated steel and 24 K73 triple prong hooks	Brackets in Medium Gray, Sandstone, Black, Lunar White or Bronze Metallic. Shelf Tubes in Anodized Aluminum. Hooks in Charcoal Gray, Black or Sandstone.	1,171.00
	WKO2A-AL-10	19 3/4"	9 to 10 ft	11 1/2"	Approx 7 lbs per ft	Double shelf hook style wall rack with silver anodized aluminum shelf tubes, 4 brackets in powder coated steel and 24 K73 triple prong hooks	Brackets in Medium Gray, Sandstone, Black, Lunar White or Bronze Metallic. Shelf Tubes in Anodized Aluminum. Hooks in Charcoal Gray, Black or Sandstone.	1,225.00
	WKO2A-AL-11	19 3/4"	10 to 11 ft	11 1/2"	Approx 7 lbs per ft	Double shelf hook style wall rack with silver anodized aluminum shelf tubes, 5 brackets in powder coated steel and 32 K73 triple prong hooks	Brackets in Medium Gray, Sandstone, Black, Lunar White or Bronze Metallic. Shelf Tubes in Anodized Aluminum. Hooks in Charcoal Gray, Black or Sandstone.	1,352.00
	WKO2A-AL-12	19 3/4"	11 to 12 ft	11 1/2"	Approx 7 lbs per ft	Double shelf hook style wall rack with silver anodized aluminum shelf tubes, 5 brackets in powder coated steel and 32 K73 triple prong hooks	Brackets in Medium Gray, Sandstone, Black, Lunar White or Bronze Metallic. Shelf Tubes in Anodized Aluminum. Hooks in Charcoal Gray, Black or Sandstone.	1,486.00
	WKO2A-AL-13	19 3/4"	12 to 13 ft	11 1/2"	Approx 7 lbs per ft	Double shelf hook style wall rack with silver anodized aluminum shelf tubes, 5 brackets in powder coated steel and 32 K73 triple prong hooks	Brackets in Medium Gray, Sandstone, Black, Lunar White or Bronze Metallic. Shelf Tubes in Anodized Aluminum. Hooks in Charcoal Gray, Black or Sandstone.	1,630.00
	WKO2A-AL-14	19 3/4"	13 to 14 ft	11 1/2"	Approx 7 lbs per ft	Double shelf hook style wall rack with silver anodized aluminum shelf tubes, 6 brackets in powder coated steel and 40 K73 triple prong hooks	Brackets in Medium Gray, Sandstone, Black, Lunar White or Bronze Metallic. Shelf Tubes in Anodized Aluminum. Hooks in Charcoal Gray, Black or Sandstone.	1,767.00
	WKO2A-AL-15	19 3/4"	14 to 15 ft	11 1/2"	Approx 7 lbs per ft	Double shelf hook style wall rack with silver anodized aluminum shelf tubes, 6 brackets in powder coated steel and 40 K73 triple prong hooks	Brackets in Medium Gray, Sandstone, Black, Lunar White or Bronze Metallic. Shelf Tubes in Anodized Aluminum. Hooks in Charcoal Gray, Black or Sandstone.	1,884.00
	WKO2A-AL-16	19 3/4"	15 to 16 ft	11 1/2"	Approx 7 lbs per ft	Double shelf hook style wall rack with silver anodized aluminum shelf tubes, 6 brackets in powder coated steel and 40 K73 triple prong hooks	Brackets in Medium Gray, Sandstone, Black, Lunar White or Bronze Metallic. Shelf Tubes in Anodized Aluminum. Hooks in Charcoal Gray, Black or Sandstone.	2,015.00

	WKO2A-AL-17	19 3/4"	16 to 17 ft	11 1/2"	Approx 7 lbs per ft	Double shelf hook style wall rack with silver anodized aluminum shelf tubes, 7 brackets in powder coated steel and 48 K73 triple prong hooks	Brackets in Medium Gray, Sandstone, Black, Lunar White or Bronze Metallic. Shelf Tubes in Anodized Aluminum. Hooks in Charcoal Gray, Black or Sandstone.	2,135.00
	WKO2A-AL-18	19 3/4"	17 to 18 ft	11 1/2"	Approx 7 lbs per ft	Double shelf hook style wall rack with silver anodized aluminum shelf tubes, 7 brackets in powder coated steel and 48 K73 triple prong hooks	Brackets in Medium Gray, Sandstone, Black, Lunar White or Bronze Metallic. Shelf Tubes in Anodized Aluminum. Hooks in Charcoal Gray, Black or Sandstone.	2,260.00
	WKO2A-AL-19	19 3/4"	18 to 19 ft	11 1/2"	Approx 7 lbs per ft	Double shelf hook style wall rack with silver anodized aluminum shelf tubes, 7 brackets in powder coated steel and 48 K73 triple prong hooks	Brackets in Medium Gray, Sandstone, Black, Lunar White or Bronze Metallic. Shelf Tubes in Anodized Aluminum. Hooks in Charcoal Gray, Black or Sandstone.	2,386.00
	WKO2A-AL-20	19 3/4"	19 to 20 ft	11 1/2"	Approx 7 lbs per ft	Double shelf hook style wall rack with silver anodized aluminum shelf tubes, 7 brackets in powder coated steel and 48 K73 triple prong hooks	Brackets in Medium Gray, Sandstone, Black, Lunar White or Bronze Metallic. Shelf Tubes in Anodized Aluminum. Hooks in Charcoal Gray, Black or Sandstone.	2,508.00

VILLA UTILITY/BOOT WALL RACK (WU01A)

BRACKET FINISH COLORS



Medium Grey Black Sandstone Lunar White Bronze Metallic

SHELF TUBE FINISH COLORS



Medium Grey Black Sandstone Lunar White Bronze Metallic

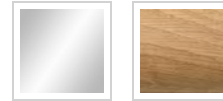

Anodized Aluminum Natural Oak

HOW TO ORDER



Determine Hook Rail Width/Model #1
Select Shelf Tube Material/Color #2
Select Bracket Color #3

Example Order: WU01A-OK-4 in Lunar White - 3' 6" wide WU01A Wall Rack in Lunar White with Natural Oak Shelf Tubes.

ADDITIONAL NOTES

CUSTOM WIDTH & PRICING

Villa Wall Racks are made to order with custom widths available to the nearest whole inch. Magnuson Group does not size to fractional inches (i.e. 12' 8 ¾" wide would be instead cut to 12' 8" wide).

When determining the model that corresponds to the custom width specified, round up to the nearest foot. For example, a 12' 3" wide WU01A unit would be priced using model WU01A-13 - this pricing would be the same for any WU01A unit with a width between 12' 1" and 13'.

MITRED CORNERS

For continuous shelving in L or U shaped wall configurations, Mitred Corners are available. Exact dimensions of each wall are required for pricing.

\$105.00 per corner per shelf.

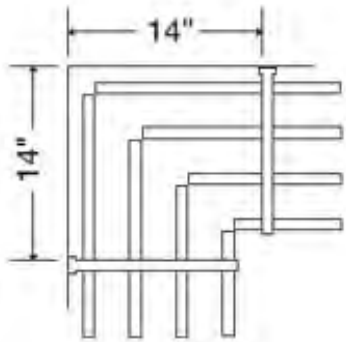

ADDITIONAL NOTES

Ships UPS where possible, otherwise Common Carrier is used.









For pricing on longer lengths, contact Customer Service.









Sample chips available.













Submittal drawings available upon request.













Hardware to secure the mounting brackets to the wall is not included due to the variety of possible surface applications.















LINE ART	MODEL	H	W	D	WEIGHT	DESCRIPTION	COLOR/FINISH	LIST PRICE
	WU01A-ST-2	13 1/2"	1 to 2 ft	11 1/2"	Approx 4 lbs per ft	Single shelf utility/boot shelf in powder coated steel finish with 2 brackets	Brackets in Medium Gray, Sandstone, Black, Lunar White or Bronze Metallic. Shelf Tubes in Medium Gray, Sandstone, Black, Lunar White or Bronze Metallic.	177.00
	WU01A-ST-3	13 1/2"	2 to 3 ft	11 1/2"	Approx 4 lbs per ft	Single shelf utility/boot shelf in powder coated steel finish with 2 brackets	Brackets in Medium Gray, Sandstone, Black, Lunar White or Bronze Metallic. Shelf Tubes in Medium Gray, Sandstone, Black, Lunar White or Bronze Metallic.	218.00
	WU01A-ST-4	13 1/2"	3 to 4 ft	11 1/2"	Approx 4 lbs per ft	Single shelf utility/boot shelf in powder coated steel finish with 2 brackets	Brackets in Medium Gray, Sandstone, Black, Lunar White or Bronze Metallic. Shelf Tubes in Medium Gray, Sandstone, Black, Lunar White or Bronze Metallic.	283.00
	WU01A-ST-5	13 1/2"	4 to 5 ft	11 1/2"	Approx 4 lbs per ft	Single shelf utility/boot shelf in powder coated steel finish with 3 brackets	Brackets in Medium Gray, Sandstone, Black, Lunar White or Bronze Metallic. Shelf Tubes in Medium Gray, Sandstone, Black, Lunar White or Bronze Metallic.	318.00
	WU01A-ST-6	13 1/2"	5 to 6 ft	11 1/2"	Approx 4 lbs per ft	Single shelf utility/boot shelf in powder coated steel finish with 3 brackets	Brackets in Medium Gray, Sandstone, Black, Lunar White or Bronze Metallic. Shelf Tubes in Medium Gray, Sandstone, Black, Lunar White or Bronze Metallic.	350.00
	WU01A-ST-7	13 1/2"	6 to 7 ft	11 1/2"	Approx 4 lbs per ft	Single shelf utility/boot shelf in powder coated steel finish with 3 brackets	Brackets in Medium Gray, Sandstone, Black, Lunar White or Bronze Metallic. Shelf Tubes in Medium Gray, Sandstone, Black, Lunar White or Bronze Metallic.	364.00
	WU01A-ST-8	13 1/2"	7 to 8 ft	11 1/2"	Approx 4 lbs per ft	Single shelf utility/boot shelf in powder coated steel finish with 4 brackets	Brackets in Medium Gray, Sandstone, Black, Lunar White or Bronze Metallic. Shelf Tubes in Medium Gray, Sandstone, Black, Lunar White or Bronze Metallic.	390.00
	WU01A-ST-9	13 1/2"	8 to 9 ft	11 1/2"	Approx 4 lbs per ft	Single shelf utility/boot shelf in powder coated steel finish with 4 brackets	Brackets in Medium Gray, Sandstone, Black, Lunar White or Bronze Metallic. Shelf Tubes in Medium Gray, Sandstone, Black, Lunar White or Bronze Metallic.	412.00
	WU01A-ST-10	13 1/2"	9 to 10 ft	11 1/2"	Approx 4 lbs per ft	Single shelf utility/boot shelf in powder coated steel finish with 4 brackets	Brackets in Medium Gray, Sandstone, Black, Lunar White or Bronze Metallic. Shelf Tubes in Medium Gray, Sandstone, Black, Lunar White or Bronze Metallic.	474.00

	WU01A-ST-11	13 1/2"	10 to 11 ft	11 1/2"	Approx 4 lbs per ft	Single shelf utility/boot shelf in powder coated steel finish with 5 brackets	Brackets in Medium Gray, Sandstone, Black, Lunar White or Bronze Metallic. Shelf Tubes in Medium Gray, Sandstone, Black, Lunar White or Bronze Metallic.	523.00
	WU01A-ST-12	13 1/2"	11 to 12 ft	11 1/2"	Approx 4 lbs per ft	Single shelf utility/boot shelf in powder coated steel finish with 5 brackets	Brackets in Medium Gray, Sandstone, Black, Lunar White or Bronze Metallic. Shelf Tubes in Medium Gray, Sandstone, Black, Lunar White or Bronze Metallic.	541.00
	WU01A-ST-13	13 1/2"	12 to 13 ft	11 1/2"	Approx 4 lbs per ft	Single shelf utility/boot shelf in powder coated steel finish with 5 brackets	Brackets in Medium Gray, Sandstone, Black, Lunar White or Bronze Metallic. Shelf Tubes in Medium Gray, Sandstone, Black, Lunar White or Bronze Metallic.	562.00
	WU01A-ST-14	13 1/2"	13 to 14 ft	11 1/2"	Approx 4 lbs per ft	Single shelf utility/boot shelf in powder coated steel finish with 6 brackets	Brackets in Medium Gray, Sandstone, Black, Lunar White or Bronze Metallic. Shelf Tubes in Medium Gray, Sandstone, Black, Lunar White or Bronze Metallic.	593.00
	WU01A-ST-15	13 1/2"	14 to 15 ft	11 1/2"	Approx 4 lbs per ft	Single shelf utility/boot shelf in powder coated steel finish with 6 brackets	Brackets in Medium Gray, Sandstone, Black, Lunar White or Bronze Metallic. Shelf Tubes in Medium Gray, Sandstone, Black, Lunar White or Bronze Metallic.	686.00
	WU01A-ST-16	13 1/2"	15 to 16 ft	11 1/2"	Approx 4 lbs per ft	Single shelf utility/boot shelf in powder coated steel finish with 6 brackets	Brackets in Medium Gray, Sandstone, Black, Lunar White or Bronze Metallic. Shelf Tubes in Medium Gray, Sandstone, Black, Lunar White or Bronze Metallic.	716.00
	WU01A-ST-17	13 1/2"	16 to 17 ft	11 1/2"	Approx 4 lbs per ft	Single shelf utility/boot shelf in powder coated steel finish with 7 brackets	Brackets in Medium Gray, Sandstone, Black, Lunar White or Bronze Metallic. Shelf Tubes in Medium Gray, Sandstone, Black, Lunar White or Bronze Metallic.	766.00
	WU01A-ST-18	13 1/2"	17 to 18 ft	11 1/2"	Approx 4 lbs per ft	Single shelf utility/boot shelf in powder coated steel finish with 7 brackets	Brackets in Medium Gray, Sandstone, Black, Lunar White or Bronze Metallic. Shelf Tubes in Medium Gray, Sandstone, Black, Lunar White or Bronze Metallic.	821.00
	WU01A-ST-19	13 1/2"	18 to 19 ft	11 1/2"	Approx 4 lbs per ft	Single shelf utility/boot shelf in powder coated steel finish with 7 brackets	Brackets in Medium Gray, Sandstone, Black, Lunar White or Bronze Metallic. Shelf Tubes in Medium Gray, Sandstone, Black, Lunar White or Bronze Metallic.	873.00

	WU01A-ST-20	13 1/2"	19 to 20 ft	11 1/2"	Approx 4 lbs per ft	Single shelf utility/boot shelf in powder coated steel finish with 7 brackets	Brackets in Medium Gray, Sandstone, Black, Lunar White or Bronze Metallic. Shelf Tubes in Medium Gray, Sandstone, Black, Lunar White or Bronze Metallic.	929.00
	WU01A-AL-2	13 1/2"	1 to 2 ft	11 1/2"	Approx 4 lbs per ft	Single shelf utility/boot shelf with silver anodized aluminum tubes and 2 brackets in powder coated steel	Brackets in Medium Gray, Sandstone, Black, Lunar White or Bronze Metallic. Shelf Tubes in Anodized Aluminum.	198.00
	WU01A-AL-3	13 1/2"	2 to 3 ft	11 1/2"	Approx 4 lbs per ft	Single shelf utility/boot shelf with silver anodized aluminum tubes and 2 brackets in powder coated steel	Brackets in Medium Gray, Sandstone, Black, Lunar White or Bronze Metallic. Shelf Tubes in Anodized Aluminum.	252.00
	WU01A-AL-4	13 1/2"	3 to 4 ft	11 1/2"	Approx 4 lbs per ft	Single shelf utility/boot shelf with silver anodized aluminum tubes and 2 brackets in powder coated steel	Brackets in Medium Gray, Sandstone, Black, Lunar White or Bronze Metallic. Shelf Tubes in Anodized Aluminum.	309.00
	WU01A-AL-5	13 1/2"	4 to 5 ft	11 1/2"	Approx 4 lbs per ft	Single shelf utility/boot shelf with silver anodized aluminum tubes and 3 brackets in powder coated steel	Brackets in Medium Gray, Sandstone, Black, Lunar White or Bronze Metallic. Shelf Tubes in Anodized Aluminum.	377.00
	WU01A-AL-6	13 1/2"	5 to 6 ft	11 1/2"	Approx 4 lbs per ft	Single shelf utility/boot shelf with silver anodized aluminum tubes and 3 brackets in powder coated steel	Brackets in Medium Gray, Sandstone, Black, Lunar White or Bronze Metallic. Shelf Tubes in Anodized Aluminum.	399.00
	WU01A-AL-7	13 1/2"	6 to 7 ft	11 1/2"	Approx 4 lbs per ft	Single shelf utility/boot shelf with silver anodized aluminum tubes and 3 brackets in powder coated steel	Brackets in Medium Gray, Sandstone, Black, Lunar White or Bronze Metallic. Shelf Tubes in Anodized Aluminum.	412.00
	WU01A-AL-8	13 1/2"	7 to 8 ft	11 1/2"	Approx 4 lbs per ft	Single shelf utility/boot shelf with silver anodized aluminum tubes and 4 brackets in powder coated steel	Brackets in Medium Gray, Sandstone, Black, Lunar White or Bronze Metallic. Shelf Tubes in Anodized Aluminum.	485.00
	WU01A-AL-9	13 1/2"	8 to 9 ft	11 1/2"	Approx 4 lbs per ft	Single shelf utility/boot shelf with silver anodized aluminum tubes and 4 brackets in powder coated steel	Brackets in Medium Gray, Sandstone, Black, Lunar White or Bronze Metallic. Shelf Tubes in Anodized Aluminum.	503.00
	WU01A-AL-10	13 1/2"	9 to 10 ft	11 1/2"	Approx 4 lbs per ft	Single shelf utility/boot shelf with silver anodized aluminum tubes and 4 brackets in powder coated steel	Brackets in Medium Gray, Sandstone, Black, Lunar White or Bronze Metallic. Shelf Tubes in Anodized Aluminum.	540.00
	WU01A-AL-11	13 1/2"	10 to 11 ft	11 1/2"	Approx 4 lbs per ft	Single shelf utility/boot shelf with silver anodized aluminum tubes and 5 brackets in powder coated steel	Brackets in Medium Gray, Sandstone, Black, Lunar White or Bronze Metallic. Shelf Tubes in Anodized Aluminum.	600.00
	WU01A-AL-12	13 1/2"	11 to 12 ft	11 1/2"	Approx 4 lbs per ft	Single shelf utility/boot shelf with silver anodized aluminum tubes and 5 brackets in powder coated steel	Brackets in Medium Gray, Sandstone, Black, Lunar White or Bronze Metallic. Shelf Tubes in Anodized Aluminum.	616.00

	WU01A-AL-13	13 1/2"	12 to 13 ft	11 1/2"	Approx 4 lbs per ft	Single shelf utility/boot shelf with silver anodized aluminum tubes and 5 brackets in powder coated steel	Brackets in Medium Gray, Sandstone, Black, Lunar White or Bronze Metallic. Shelf Tubes in Anodized Aluminum.	644.00
	WU01A-AL-14	13 1/2"	13 to 14 ft	11 1/2"	Approx 4 lbs per ft	Single shelf utility/boot shelf with silver anodized aluminum tubes and 6 brackets in powder coated steel	Brackets in Medium Gray, Sandstone, Black, Lunar White or Bronze Metallic. Shelf Tubes in Anodized Aluminum.	669.00
	WU01A-AL-15	13 1/2"	14 to 15 ft	11 1/2"	Approx 4 lbs per ft	Single shelf utility/boot shelf with silver anodized aluminum tubes and 6 brackets in powder coated steel	Brackets in Medium Gray, Sandstone, Black, Lunar White or Bronze Metallic. Shelf Tubes in Anodized Aluminum.	765.00
	WU01A-AL-16	13 1/2"	15 to 16 ft	11 1/2"	Approx 4 lbs per ft	Single shelf utility/boot shelf with silver anodized aluminum tubes and 6 brackets in powder coated steel	Brackets in Medium Gray, Sandstone, Black, Lunar White or Bronze Metallic. Shelf Tubes in Anodized Aluminum.	810.00
	WU01A-AL-17	13 1/2"	16 to 17 ft	11 1/2"	Approx 4 lbs per ft	Single shelf utility/boot shelf with silver anodized aluminum tubes and 7 brackets in powder coated steel	Brackets in Medium Gray, Sandstone, Black, Lunar White or Bronze Metallic. Shelf Tubes in Anodized Aluminum.	868.00
	WU01A-AL-18	13 1/2"	17 to 18 ft	11 1/2"	Approx 4 lbs per ft	Single shelf utility/boot shelf with silver anodized aluminum tubes and 7 brackets in powder coated steel	Brackets in Medium Gray, Sandstone, Black, Lunar White or Bronze Metallic. Shelf Tubes in Anodized Aluminum.	931.00
	WU01A-AL-19	13 1/2"	18 to 19 ft	11 1/2"	Approx 4 lbs per ft	Single shelf utility/boot shelf with silver anodized aluminum tubes and 7 brackets in powder coated steel	Brackets in Medium Gray, Sandstone, Black, Lunar White or Bronze Metallic. Shelf Tubes in Anodized Aluminum.	996.00
	WU01A-AL-20	13 1/2"	19 to 20 ft	11 1/2"	Approx 4 lbs per ft	Single shelf utility/boot shelf with silver anodized aluminum tubes and 7 brackets in powder coated steel	Brackets in Medium Gray, Sandstone, Black, Lunar White or Bronze Metallic. Shelf Tubes in Anodized Aluminum.	1,057.00
	WU01A-OK-2	13 1/2"	1 to 2 ft	11 1/2"	Approx 4 lbs per ft	Single shelf utility/boot shelf with 3/4" square oak shelf bars and 2 brackets in powder coated steel	Brackets in Medium Gray, Sandstone, Black, Lunar White or Bronze Metallic. Shelf Tubes in Natural Oak.	218.00
	WU01A-OK-3	13 1/2"	2 to 3 ft	11 1/2"	Approx 4 lbs per ft	Single shelf utility/boot shelf with 3/4" square oak shelf bars and 2 brackets in powder coated steel	Brackets in Medium Gray, Sandstone, Black, Lunar White or Bronze Metallic. Shelf Tubes in Natural Oak.	264.00
	WU01A-OK-4	13 1/2"	3 to 4 ft	11 1/2"	Approx 4 lbs per ft	Single shelf utility/boot shelf with 3/4" square oak shelf bars and 2 brackets in powder coated steel	Brackets in Medium Gray, Sandstone, Black, Lunar White or Bronze Metallic. Shelf Tubes in Natural Oak.	325.00
	WU01A-OK-5	13 1/2"	4 to 5 ft	11 1/2"	Approx 4 lbs per ft	Single shelf utility/boot shelf with 3/4" square oak shelf bars and 3 brackets in powder coated steel	Brackets in Medium Gray, Sandstone, Black, Lunar White or Bronze Metallic. Shelf Tubes in Natural Oak.	408.00
	WU01A-OK-6	13 1/2"	5 to 6 ft	11 1/2"	Approx 4 lbs per ft	Single shelf utility/boot shelf with 3/4" square oak shelf bars and 3 brackets in powder coated steel	Brackets in Medium Gray, Sandstone, Black, Lunar White or Bronze Metallic. Shelf Tubes in Natural Oak.	491.00

	WU01A-OK-7	13 1/2"	6 to 7 ft	11 1/2"	Approx 4 lbs per ft	Single shelf utility/boot shelf with 3/4" square oak shelf bars and 3 brackets in powder coated steel	Brackets in Medium Gray, Sandstone, Black, Lunar White or Bronze Metallic. Shelf Tubes in Natural Oak.	514.00
	WU01A-OK-8	13 1/2"	7 to 8 ft	11 1/2"	Approx 4 lbs per ft	Single shelf utility/boot shelf with 3/4" square oak shelf bars and 4 brackets in powder coated steel	Brackets in Medium Gray, Sandstone, Black, Lunar White or Bronze Metallic. Shelf Tubes in Natural Oak.	551.00
	WU01A-OK-9	13 1/2"	8 to 9 ft	11 1/2"	Approx 4 lbs per ft	Single shelf utility/boot shelf with 3/4" square oak shelf bars and 4 brackets in powder coated steel	Brackets in Medium Gray, Sandstone, Black, Lunar White or Bronze Metallic. Shelf Tubes in Natural Oak.	599.00
	WU01A-OK-10	13 1/2"	9 to 10 ft	11 1/2"	Approx 4 lbs per ft	Single shelf utility/boot shelf with 3/4" square oak shelf bars and 4 brackets in powder coated steel	Brackets in Medium Gray, Sandstone, Black, Lunar White or Bronze Metallic. Shelf Tubes in Natural Oak.	667.00
	WU01A-OK-11	13 1/2"	10 to 11 ft	11 1/2"	Approx 4 lbs per ft	Single shelf utility/boot shelf with 3/4" square oak shelf bars and 5 brackets in powder coated steel	Brackets in Medium Gray, Sandstone, Black, Lunar White or Bronze Metallic. Shelf Tubes in Natural Oak.	742.00
	WU01A-OK-12	13 1/2"	11 to 12 ft	11 1/2"	Approx 4 lbs per ft	Single shelf utility/boot shelf with 3/4" square oak shelf bars and 5 brackets in powder coated steel	Brackets in Medium Gray, Sandstone, Black, Lunar White or Bronze Metallic. Shelf Tubes in Natural Oak.	805.00
	WU01A-OK-13	13 1/2"	12 to 13 ft	11 1/2"	Approx 4 lbs per ft	Single shelf utility/boot shelf with 3/4" square oak shelf bars and 5 brackets in powder coated steel	Brackets in Medium Gray, Sandstone, Black, Lunar White or Bronze Metallic. Shelf Tubes in Natural Oak.	945.00
	WU01A-OK-14	13 1/2"	13 to 14 ft	11 1/2"	Approx 4 lbs per ft	Single shelf utility/boot shelf with 3/4" square oak shelf bars and 6 brackets in powder coated steel	Brackets in Medium Gray, Sandstone, Black, Lunar White or Bronze Metallic. Shelf Tubes in Natural Oak.	1,014.00
	WU01A-OK-15	13 1/2"	14 to 15 ft	11 1/2"	Approx 4 lbs per ft	Single shelf utility/boot shelf with 3/4" square oak shelf bars and 6 brackets in powder coated steel	Brackets in Medium Gray, Sandstone, Black, Lunar White or Bronze Metallic. Shelf Tubes in Natural Oak.	1,079.00
	WU01A-OK-16	13 1/2"	15 to 16 ft	11 1/2"	Approx 4 lbs per ft	Single shelf utility/boot shelf with 3/4" square oak shelf bars and 6 brackets in powder coated steel	Brackets in Medium Gray, Sandstone, Black, Lunar White or Bronze Metallic. Shelf Tubes in Natural Oak.	1,113.00
	WU01A-OK-17	13 1/2"	16 to 17 ft	11 1/2"	Approx 4 lbs per ft	Single shelf utility/boot shelf with 3/4" square oak shelf bars and 7 brackets in powder coated steel	Brackets in Medium Gray, Sandstone, Black, Lunar White or Bronze Metallic. Shelf Tubes in Natural Oak.	1,184.00
	WU01A-OK-18	13 1/2"	17 to 18 ft	11 1/2"	Approx 4 lbs per ft	Single shelf utility/boot shelf with 3/4" square oak shelf bars and 7 brackets in powder coated steel	Brackets in Medium Gray, Sandstone, Black, Lunar White or Bronze Metallic. Shelf Tubes in Natural Oak.	1,256.00
	WU01A-OK-19	13 1/2"	18 to 19 ft	11 1/2"	Approx 4 lbs per ft	Single shelf utility/boot shelf with 3/4" square oak shelf bars and 7 brackets in powder coated steel	Brackets in Medium Gray, Sandstone, Black, Lunar White or Bronze Metallic. Shelf Tubes in Natural Oak.	1,333.00

WU01A-OK-20	13 1/2"	19 to 20 ft	11 1/2"	Approx 4 lbs per ft	Single shelf utility/boot shelf with 3/4" square oak shelf bars and 7 brackets in powder coated steel	Brackets in Medium Gray, Sandstone, Black, Lunar White or Bronze Metallic. Shelf Tubes in Natural Oak.	1,402.00
-------------	---------	-------------	---------	------------------------	--	---	----------



VILLA HOOK STRIP (WEX)

BRACKETS



Medium Grey Black

Sandstone

Lunar White

Bronze
Metallic

HOOK RAIL FINISH COLORS



Medium Grey Black

Sandstone

Lunar White

Bronze
Metallic



Anodized
Aluminum

HOOK FINISH COLORS



Charcoal
Grey

Sandstone

Black

HOW TO ORDER



Determine Hook Rail Width/Model Select Bracket, Rail & Hook Color

Example Order: WEX-ST-11 in Black with Black Hooks - 10' 9" wide WEX Hook Strip with Black Brackets, Black Rail & Black Hooks.

ADDITIONAL NOTES

PRODUCT APPLICATION & CUSTOM WIDTH

The Custom Villa Hook Strip can be used as a standalone product, mounted to the wall with brackets and used as a hook strip.

The Custom Villa Hook Strip can also be used below other Villa wall rack models, to provide coat, hat, bookbag or other storage below the shelf.

Villa Wall Racks are made to order with custom widths available to the nearest whole inch. Magnuson Group does not size to fractional inches (i.e. 12' 8 3/4" wide would be instead cut to 12' 8" wide).

When determining the model that corresponds to the custom width specified, round up to the nearest foot. For example, a 12' 3" wide WEX unit would be priced using model WEX-13 - this pricing would be the same for any WEX unit with a width between 12' 1" and 13'.

ADDITIONAL NOTES

Ships UPS where possible, otherwise Common Carrier is used.

Custom Villa WEX hook strips can be stand alone or be incorporated with any WH, WK or WU wall rack.

When used alone, hook strips are mounted on a 13 1/2" wall mount.



The rail bracket, the component that attaches the hook rail to the wall mounted u-channel bracket, is always painted black.









For pricing on longer lengths, contact Customer Service.









Sample chips available.









Submittal drawings are available upon request.









Hardware to secure the mounting brackets to the wall is not included due to the variety of possible surface applications.

LINE ART	MODEL	H	W	D	WEIGHT	DESCRIPTION	COLOR/FINISH	LIST PRICE
	WEX-ST-2	13 1/2"	1 to 2 ft	3"	Approx 2 lbs per ft	Powder coated steel hook rail with 2 K73 powder coated steel triple prong hooks	Brackets in Medium Gray, Sandstone, Black, Lunar White or Bronze Metallic. Rail in Medium Gray, Sandstone, Black, Lunar White or Bronze Metallic. Hooks in Charcoal Gray, Black or Sandstone.	75.00
	WEX-ST-3	13 1/2"	2 to 3 ft	3"	Approx 2 lbs per ft	Powder coated steel hook rail with 3 K73 powder coated steel triple prong hooks	Brackets in Medium Gray, Sandstone, Black, Lunar White or Bronze Metallic. Rail in Medium Gray, Sandstone, Black, Lunar White or Bronze Metallic. Hooks in Charcoal Gray, Black or Sandstone.	107.00
	WEX-ST-4	13 1/2"	3 to 4 ft	3"	Approx 2 lbs per ft	Powder coated steel hook rail with 4 K73 powder coated steel triple prong hooks	Brackets in Medium Gray, Sandstone, Black, Lunar White or Bronze Metallic. Rail in Medium Gray, Sandstone, Black, Lunar White or Bronze Metallic. Hooks in Charcoal Gray, Black or Sandstone.	142.00

	WEX-ST-5	13 1/2"	4 to 5 ft	3"	Approx 2 lbs per ft	Powder coated steel hook rail with 6 K73 powder coated steel triple prong hooks	Brackets in Medium Gray, Sandstone, Black, Lunar White or Bronze Metallic. Rail in Medium Gray, Sandstone, Black, Lunar White or Bronze Metallic. Hooks in Charcoal Gray, Black or Sandstone.	193.00
	WEX-ST-6	13 1/2"	5 to 6 ft	3"	Approx 2 lbs per ft	Powder coated steel hook rail with 8 K73 powder coated steel triple prong hooks	Brackets in Medium Gray, Sandstone, Black, Lunar White or Bronze Metallic. Rail in Medium Gray, Sandstone, Black, Lunar White or Bronze Metallic. Hooks in Charcoal Gray, Black or Sandstone.	245.00
	WEX-ST-7	13 1/2"	6 to 7 ft	3"	Approx 2 lbs per ft	Powder coated steel hook rail with 8 K73 powder coated steel triple prong hooks	Brackets in Medium Gray, Sandstone, Black, Lunar White or Bronze Metallic. Rail in Medium Gray, Sandstone, Black, Lunar White or Bronze Metallic. Hooks in Charcoal Gray, Black or Sandstone.	261.00
	WEX-ST-8	13 1/2"	7 to 8 ft	3"	Approx 2 lbs per ft	Powder coated steel hook rail with 9 K73 powder coated steel triple prong hooks	Brackets in Medium Gray, Sandstone, Black, Lunar White or Bronze Metallic. Rail in Medium Gray, Sandstone, Black, Lunar White or Bronze Metallic. Hooks in Charcoal Gray, Black or Sandstone.	292.00
	WEX-ST-9	13 1/2"	8 to 9 ft	3"	Approx 2 lbs per ft	Powder coated steel hook rail with 12 K73 powder coated steel triple prong hooks	Brackets in Medium Gray, Sandstone, Black, Lunar White or Bronze Metallic. Rail in Medium Gray, Sandstone, Black, Lunar White or Bronze Metallic. Hooks in Charcoal Gray, Black or Sandstone.	362.00
	WEX-ST-10	13 1/2"	9 to 10 ft	3"	Approx 2 lbs per ft	Powder coated steel hook rail with 12 K73 powder coated steel triple prong hooks	Brackets in Medium Gray, Sandstone, Black, Lunar White or Bronze Metallic. Rail in Medium Gray, Sandstone, Black, Lunar White or Bronze Metallic. Hooks in Charcoal Gray, Black or Sandstone.	381.00
	WEX-ST-11	13 1/2"	10 to 11 ft	3"	Approx 2 lbs per ft	Powder coated steel hook rail with 16 K73 powder coated steel triple prong hooks	Brackets in Medium Gray, Sandstone, Black, Lunar White or Bronze Metallic. Rail in Medium Gray, Sandstone, Black, Lunar White or Bronze Metallic. Hooks in Charcoal Gray, Black or Sandstone.	462.00
	WEX-ST-12	13 1/2"	11 to 12 ft	3"	Approx 2 lbs per ft	Powder coated steel hook rail with 16 K73 powder coated steel triple prong hooks	Brackets in Medium Gray, Sandstone, Black, Lunar White or Bronze Metallic. Rail in Medium Gray, Sandstone, Black, Lunar White or Bronze Metallic. Hooks in Charcoal Gray, Black or Sandstone.	479.00

	WEX-ST-13	13 1/2"	12 to 13 ft	3"	Approx 2 lbs per ft	Powder coated steel hook rail with 16 K73 powder coated steel triple prong hooks	Brackets in Medium Gray, Sandstone, Black, Lunar White or Bronze Metallic. Rail in Medium Gray, Sandstone, Black, Lunar White or Bronze Metallic. Hooks in Charcoal Gray, Black or Sandstone.	494.00
	WEX-ST-14	13 1/2"	13 to 14 ft	3"	Approx 2 lbs per ft	Powder coated steel hook rail with 20 K73 powder coated steel triple prong hooks	Brackets in Medium Gray, Sandstone, Black, Lunar White or Bronze Metallic. Rail in Medium Gray, Sandstone, Black, Lunar White or Bronze Metallic. Hooks in Charcoal Gray, Black or Sandstone.	578.00
	WEX-ST-15	13 1/2"	14 to 15 ft	3"	Approx 2 lbs per ft	Powder coated steel hook rail with 20 K73 powder coated steel triple prong hooks	Brackets in Medium Gray, Sandstone, Black, Lunar White or Bronze Metallic. Rail in Medium Gray, Sandstone, Black, Lunar White or Bronze Metallic. Hooks in Charcoal Gray, Black or Sandstone.	601.00
	WEX-ST-16	13 1/2"	15 to 16 ft	3"	Approx 2 lbs per ft	Powder coated steel hook rail with 20 K73 powder coated steel triple prong hooks	Brackets in Medium Gray, Sandstone, Black, Lunar White or Bronze Metallic. Rail in Medium Gray, Sandstone, Black, Lunar White or Bronze Metallic. Hooks in Charcoal Gray, Black or Sandstone.	615.00
	WEX-ST-17	13 1/2"	16 to 17 ft	3"	Approx 2 lbs per ft	Powder coated steel hook rail with 24 K73 powder coated steel triple prong hooks	Brackets in Medium Gray, Sandstone, Black, Lunar White or Bronze Metallic. Rail in Medium Gray, Sandstone, Black, Lunar White or Bronze Metallic. Hooks in Charcoal Gray, Black or Sandstone.	653.00
	WEX-ST-18	13 1/2"	17 to 18 ft	3"	Approx 2 lbs per ft	Powder coated steel hook rail with 24 K73 powder coated steel triple prong hooks	Brackets in Medium Gray, Sandstone, Black, Lunar White or Bronze Metallic. Rail in Medium Gray, Sandstone, Black, Lunar White or Bronze Metallic. Hooks in Charcoal Gray, Black or Sandstone.	689.00
	WEX-ST-19	13 1/2"	18 to 19 ft	3"	Approx 2 lbs per ft	Powder coated steel hook rail with 24 K73 powder coated steel triple prong hooks	Brackets in Medium Gray, Sandstone, Black, Lunar White or Bronze Metallic. Rail in Medium Gray, Sandstone, Black, Lunar White or Bronze Metallic. Hooks in Charcoal Gray, Black or Sandstone.	724.00
	WEX-ST-20	13 1/2"	19 to 20 ft	3"	Approx 2 lbs per ft	Powder coated steel hook rail with 24 K73 powder coated steel triple prong hooks	Brackets in Medium Gray, Sandstone, Black, Lunar White or Bronze Metallic. Rail in Medium Gray, Sandstone, Black, Lunar White or Bronze Metallic. Hooks in Charcoal Gray, Black or Sandstone.	762.00

	WEX-AL-2	13 1/2"	1 to 2 ft	3"	Approx 2 lbs per ft	Silver anodized aluminum hook rail with 2 K73 powder coated steel triple prong hooks	Brackets in Medium Gray, Sandstone, Black, Lunar White or Bronze Metallic. Rail in Anodized Aluminum. Hooks in Charcoal Gray, Black or Sandstone.	86.00
	WEX-AL-3	13 1/2"	2 to 3 ft	3"	Approx 2 lbs per ft	Silver anodized aluminum hook rail with 3 K73 powder coated steel triple prong hooks	Brackets in Medium Gray, Sandstone, Black, Lunar White or Bronze Metallic. Rail in Anodized Aluminum. Hooks in Charcoal Gray, Black or Sandstone.	119.00
	WEX-AL-4	13 1/2"	3 to 4 ft	3"	Approx 2 lbs per ft	Silver anodized aluminum hook rail with 4 K73 powder coated steel triple prong hooks	Brackets in Medium Gray, Sandstone, Black, Lunar White or Bronze Metallic. Rail in Anodized Aluminum. Hooks in Charcoal Gray, Black or Sandstone.	161.00
	WEX-AL-5	13 1/2"	4 to 5 ft	3"	Approx 2 lbs per ft	Silver anodized aluminum hook rail with 6 K73 powder coated steel triple prong hooks	Brackets in Medium Gray, Sandstone, Black, Lunar White or Bronze Metallic. Rail in Anodized Aluminum. Hooks in Charcoal Gray, Black or Sandstone.	219.00
	WEX-AL-6	13 1/2"	5 to 6 ft	3"	Approx 2 lbs per ft	Silver anodized aluminum hook rail with 8 K73 powder coated steel triple prong hooks	Brackets in Medium Gray, Sandstone, Black, Lunar White or Bronze Metallic. Rail in Anodized Aluminum. Hooks in Charcoal Gray, Black or Sandstone.	277.00
	WEX-AL-7	13 1/2"	6 to 7 ft	3"	Approx 2 lbs per ft	Silver anodized aluminum hook rail with 8 K73 powder coated steel triple prong hooks	Brackets in Medium Gray, Sandstone, Black, Lunar White or Bronze Metallic. Rail in Anodized Aluminum. Hooks in Charcoal Gray, Black or Sandstone.	297.00
	WEX-AL-8	13 1/2"	7 to 8 ft	3"	Approx 2 lbs per ft	Silver anodized aluminum hook rail with 9 K73 powder coated steel triple prong hooks	Brackets in Medium Gray, Sandstone, Black, Lunar White or Bronze Metallic. Rail in Anodized Aluminum. Hooks in Charcoal Gray, Black or Sandstone.	339.00
	WEX-AL-9	13 1/2"	8 to 9 ft	3"	Approx 2 lbs per ft	Silver anodized aluminum hook rail with 12 K73 powder coated steel triple prong hooks	Brackets in Medium Gray, Sandstone, Black, Lunar White or Bronze Metallic. Rail in Anodized Aluminum. Hooks in Charcoal Gray, Black or Sandstone.	413.00
	WEX-AL-10	13 1/2"	9 to 10 ft	3"	Approx 2 lbs per ft	Silver anodized aluminum hook rail with 12 K73 powder coated steel triple prong hooks	Brackets in Medium Gray, Sandstone, Black, Lunar White or Bronze Metallic. Rail in Anodized Aluminum. Hooks in Charcoal Gray, Black or Sandstone.	436.00

	WEX-AL-11	13 1/2"	10 to 11 ft	3"	Approx 2 lbs per ft	Silver anodized aluminum hook rail with 16 K73 powder coated steel triple prong hooks	Brackets in Medium Gray, Sandstone, Black, Lunar White or Bronze Metallic. Rail in Anodized Aluminum. Hooks in Charcoal Gray, Black or Sandstone.	527.00
	WEX-AL-12	13 1/2"	11 to 12 ft	3"	Approx 2 lbs per ft	Silver anodized aluminum hook rail with 16 K73 powder coated steel triple prong hooks	Brackets in Medium Gray, Sandstone, Black, Lunar White or Bronze Metallic. Rail in Anodized Aluminum. Hooks in Charcoal Gray, Black or Sandstone.	551.00
	WEX-AL-13	13 1/2"	12 to 13 ft	3"	Approx 2 lbs per ft	Silver anodized aluminum hook rail with 16 K73 powder coated steel triple prong hooks	Brackets in Medium Gray, Sandstone, Black, Lunar White or Bronze Metallic. Rail in Anodized Aluminum. Hooks in Charcoal Gray, Black or Sandstone.	571.00
	WEX-AL-14	13 1/2"	13 to 14 ft	3"	Approx 2 lbs per ft	Silver anodized aluminum hook rail with 20 K73 powder coated steel triple prong hooks	Brackets in Medium Gray, Sandstone, Black, Lunar White or Bronze Metallic. Rail in Anodized Aluminum. Hooks in Charcoal Gray, Black or Sandstone.	661.00
	WEX-AL-15	13 1/2"	14 to 15 ft	3"	Approx 2 lbs per ft	Silver anodized aluminum hook rail with 20 K73 powder coated steel triple prong hooks	Brackets in Medium Gray, Sandstone, Black, Lunar White or Bronze Metallic. Rail in Anodized Aluminum. Hooks in Charcoal Gray, Black or Sandstone.	689.00
	WEX-AL-16	13 1/2"	15 to 16 ft	3"	Approx 2 lbs per ft	Silver anodized aluminum hook rail with 20 K73 powder coated steel triple prong hooks	Brackets in Medium Gray, Sandstone, Black, Lunar White or Bronze Metallic. Rail in Anodized Aluminum. Hooks in Charcoal Gray, Black or Sandstone.	709.00
	WEX-AL-17	13 1/2"	16 to 17 ft	3"	Approx 2 lbs per ft	Silver anodized aluminum hook rail with 24 K73 powder coated steel triple prong hooks	Brackets in Medium Gray, Sandstone, Black, Lunar White or Bronze Metallic. Rail in Anodized Aluminum. Hooks in Charcoal Gray, Black or Sandstone.	724.00
	WEX-AL-18	13 1/2"	17 to 18 ft	3"	Approx 2 lbs per ft	Silver anodized aluminum hook rail with 24 K73 powder coated steel triple prong hooks	Brackets in Medium Gray, Sandstone, Black, Lunar White or Bronze Metallic. Rail in Anodized Aluminum. Hooks in Charcoal Gray, Black or Sandstone.	754.00
	WEX-AL-19	13 1/2"	18 to 19 ft	3"	Approx 2 lbs per ft	Silver anodized aluminum hook rail with 24 K73 powder coated steel triple prong hooks	Brackets in Medium Gray, Sandstone, Black, Lunar White or Bronze Metallic. Rail in Anodized Aluminum. Hooks in Charcoal Gray, Black or Sandstone.	798.00



WEX-AL-20

13 1/2"

19 to 20 ft

3"

Approx 2
lbs per ft

Silver anodized aluminum hook rail with 24 K73 powder
coated steel triple prong hooks

Brackets in Medium Gray,
Sandstone, Black, Lunar White
or Bronze Metallic. Rail in
Anodized Aluminum. Hooks in
Charcoal Gray, Black or
Sandstone.

845.00

COAT HANGERS

HOME → PRODUCTS → COAT HANGERS





BASIC

ADDITIONAL NOTES

Ships via UPS





LINE ART	MODEL	H	W	D	WEIGHT	DESCRIPTION	COLOR/FINISH	LIST PRICE
	BASIC	9 3/4"	17 5/8"	11/16"	3 lbs.	Laminated Beech Veneer coat hanger with chrome hook. Quantity of 1.	Laminated Beech	25.00
	BASIC-10	9 3/4"	17 5/8"	11/16"	3 lbs.	Laminated Beech Veneer coat hanger with chrome hook. Quantity of 10.	Laminated Beech	235.00

FILO

ADDITIONAL NOTES

Ships via UPS





LINE ART	MODEL	H	W	D	WEIGHT	DESCRIPTION	COLOR/FINISH	LIST PRICE
	FILO-A	9 7/16"	17 5/16"	2 3/8"	1 lbs.	Epoxy coated wire theft deterrent closed loop hanger	White, Black, Silver or Sand	48.00
	FILO-S	9 7/16"	17 5/16"	2 3/8"	1 lbs.	Epoxy coated wire open hook hanger	White, Black, Silver or Sand	48.00

GRIP

ADDITIONAL NOTES

Ships via UPS





LINE ART	MODEL	H	W	D	WEIGHT	DESCRIPTION	COLOR/FINISH	LIST PRICE
	GRIP	9 3/4"	17 5/8"	11/16"	3 lbs.	Beech coat hanger with black rubber coating, hook in black galvanized steel. Quantity of 1.	Black	30.00
	GRIP-10	9 3/4"	17 5/8"	11/16"	3 lbs.	Beech coat hanger with black rubber coating, hook in black galvanized steel. Quantity of 10.	Black	295.00

HANGER RECEPTACLES

ADDITIONAL NOTES

Ships via UPS



LINE ART	MODEL	H	W	D	WEIGHT	DESCRIPTION	COLOR/FINISH	LIST PRICE
	R1.5	2 1/2"	1 15/16"	1/2"	1/4 lb.	Receptacle for 1 1/4" O.D. hanger rod	Plated steel	12.00
	SR.34	2 3/16"	7/8"	7/8"	1/4 lb.	Receptacle for 3/4" square tube	Black or Charcoal Grey	14.00

ADDITIONAL NOTES

Ships via UPS













LINE ART	MODEL	H	W	D	WEIGHT	DESCRIPTION	COLOR/FINISH	LIST PRICE
	MIRAC-6	3"	19 11/16"	1"	4 lbs.	Plastic coat hanger, carton of 6 each.	Transparent plastic	270.00









MOLDED POLYSTYRENE HANGERS

ADDITIONAL NOTES

Ships via UPS



LINE ART	MODEL	H	W	D	WEIGHT	DESCRIPTION	COLOR/FINISH	LIST PRICE
	MG-17PM	8 7/8"	17"	3/4"	1/4 lb.	Slotted plastic anti-theft design 1 ea	Black, Charcoal Grey	21.00
	MG-17PM-6	8 7/8"	17"	3/4"	3 lbs.	Slotted plastic anti-theft design 6 pk	Black, Charcoal Grey	78.00
	MG-17PM-24	8 7/8"	17"	3/4"	8 lbs.	Slotted plastic anti-theft design 24 pk	Black, Charcoal Grey	216.00
	MG-17PM-100	8 7/8"	17"	3/4"	30 lbs.	Slotted plastic anti-theft design 100 pk	Black, Charcoal Grey	808.00
	MG-17PH	9"	17"	3/4"	1/4 lb.	Open hook polystyrene 1 pk	Black, Charcoal Grey	21.00
	MG-17PH-6	9"	17"	3/4"	3 lbs.	Open hook polystyrene 6 pk	Black, Charcoal Grey	78.00
	MG-17PH-24	9"	17"	3/4"	8 lbs.	Open hook polystyrene 24 pk	Black, Charcoal Grey	216.00
	MG-17PH-100	9"	17"	3/4"	30 lbs.	Open hook polystyrene 100 pk	Black, Charcoal Grey	808.00
	MG-17PS	7 7/8"	17"	3/4"	1/4 lb.	Mini hook polystyrene 1 ea	Black, Charcoal Grey	21.00
	MG-17PS-6	7 7/8"	17"	3/4"	3 lbs.	Mini hook polystyrene 6 pk	Black, Charcoal Grey	78.00





	MG-17PS-24	7 7/8"	17"	3/4"	8 lbs.	Mini hook polystyrene 24 pk	Black, Charcoal Grey	216.00
	MG-17PS-100	7 7/8"	17"	3/4"	30 lbs.	Mini hook polystyrene 100 pk	Black, Charcoal Grey	808.00
	MG-17PX	6 7/8"	17"	3/4"	1/4 lb.	T-top polystyrene hanger for use with SR34 Hanger Receptacle. Quantity of 1.	Black, Charcoal Grey	21.00
	MG-17PX-24	6 7/8"	17"	3/4"	8 lbs.	T-top polystyrene hanger for use with SR34 Hanger Receptacle. Quantity of 24.	Black, Charcoal Grey	216.00
	MG-17PX-100	6 7/8"	17"	3/4"	30 lbs.	T-top polystyrene hanger for use with SR34 Hanger Receptacle. Quantity of 100.	Black, Charcoal Grey	808.00
	MG-17PP	6 7/8"	17"	3/4"	1/4 lb.	T-top polystyrene hanger for use with R1.5 Hanger Receptacle. Quantity of 1.	Black, Charcoal Grey	21.00
	MG-17PP-24	6 7/8"	17"	3/4"	8 lbs.	T-top polystyrene hanger for use with R1.5 Hanger Receptacle. Quantity of 24.	Black, Charcoal Grey	216.00
	MG-17PP-100	6 7/8"	17"	3/4"	30 lbs.	T-top polystyrene hanger for use with R1.5 Hanger Receptacle. Quantity of 100.	Black, Charcoal Grey	808.00

STEEL HANGERS

ADDITIONAL NOTES

Ships via UPS





LINE ART	MODEL	H	W	D	WEIGHT	DESCRIPTION	COLOR/FINISH	LIST PRICE
	MG-17OHN	7 5/8"	17"	1/8"	1/4 lb.	Wire open hook 1 ea	Silver	16.00
	MG-17OHN-50	7 5/8"	17"	1/8"	18 lbs.	Wire open hook 50 pk	Silver	405.00
	MG-17CL	7 5/8"	17"	1/8"	1/4 lb.	Wire closed loop hanger 1 ea	Silver	16.00
	MG-17CL-50	7 5/8"	17"	1/8"	18 lbs.	Wire closed loop hanger 50 pk	Silver	405.00

TUBULUS

ADDITIONAL NOTES

Ships via UPS



LINE ART	MODEL	H	W	D	WEIGHT	DESCRIPTION	COLOR/FINISH	LIST PRICE
	TUB-100	7 7/8"	17 1/4"	7/8"	.5 lbs.	Plastic coat hanger with stainless steel open hook.	Black 9311, White 9310, Dark Grey	48.00
	TUB-200	7 7/8"	17 1/4"	7/8"	.5 lbs.	Plastic coat hanger with theft-deterrent stainless steel closed loop.	Dark Grey or White	55.00

ADDITIONAL NOTES

Ships via UPS



LINE ART	MODEL	H	W	D	WEIGHT	DESCRIPTION	COLOR/FINISH	LIST PRICE
	UNI-20	8 1/4"	17 7/8"	3/4"	.5 lbs	Plastic coat hanger with aluminum trouser bar and open hook	Black with silver aluminum trouser bar.	48.00



HOSPITALITY RACKS

[HOME](#) → [PRODUCTS](#) → [HOSPITALITY RACKS](#)



BURR UNDER SHELF RODS & BRACKETS (USR)

BRACKET FINISH COLORS



Medium Grey

HOW TO ORDER



Determine Width/Model

Example Order: USR1000-6 - 5' 9" wide USR 1000 under shelf rod with Medium Grey Brackets and Stainless Steel Rod.

ADDITIONAL NOTES

CUSTOM WIDTH & PRICING

Burr Under Shelf Rods & Brackets are made to order with custom widths available to the nearest whole inch. Magnuson Group does not size to fractional inches (i.e. 3' 8 3/4" wide would be instead cut to 3' 8" wide).

When determining the model that corresponds to the custom width specified, round up to the nearest foot. For example, a 4' 3" wide USR unit would be priced using model USR-5 - this pricing would be the same for any USR unit with a width between 4' 1" and 5'.

ADDITIONAL NOTES

Ships UPS where possible, otherwise Common Carrier is used.

USR undershelf rod and brackets sets must be mounted to underside of existing shelf.





For pricing on longer lengths, contact Customer Service.

Sample chips available.

Submittal drawings are available upon request.



LINE ART	MODEL	H	W	D	WEIGHT	DESCRIPTION	COLOR/FINISH	LIST PRICE
	USR1000-2	2 7/16"	1 to 2 ft	3 1/8"	1 1/2 lbs.	1" o.d. stainless steel rod with 2 powder coated steel brackets	Medium Grey Bracket with Stainless Steel Rod	59.00
	USR1000-3	2 7/16"	2 to 3 ft	3 1/8"	2 lbs.	1" o.d. stainless steel rod with 2 powder coated steel brackets	Medium Grey Bracket with Stainless Steel Rod	84.00
	USR1000-4	2 7/16"	3 to 4 ft	3 1/8"	2 1/2 lbs.	1" o.d. stainless steel rod with 2 powder coated steel brackets	Medium Grey Bracket with Stainless Steel Rod	101.00

	USR1000-5	2 7/16"	4 to 5 ft	3 1/8"	3 lbs.	1" o.d. stainless steel rod with 3 powder coated steel brackets	Medium Grey Bracket with Stainless Steel Rod	147.00
	USR1000-6	2 7/16"	5 to 6 ft	3 1/8"	4 lbs.	1" o.d. stainless steel rod with 3 powder coated steel brackets	Medium Grey Bracket with Stainless Steel Rod	162.00
	USR1000-7	2 7/16"	6 to 7 ft	3 1/8"	5 lbs.	1" o.d. stainless steel rod with 3 powder coated steel brackets	Medium Grey Bracket with Stainless Steel Rod	187.00
	USR1000-8	2 7/16"	7 to 8 ft	3 1/8"	5 1/2 lbs.	1" o.d. stainless steel rod with 4 powder coated steel brackets	Medium Grey Bracket with Stainless Steel Rod	208.00